

Multi-parameter Patient Monitor

Elegant-1100

User Manual

Version: 3.0

Issued by: Sara Lo Date: 7/20/2020

Reviewed by: Albert Huang Date: 7/20/2020

Document No: UM-PM1-201405-01

North-Vision Tech. Inc.





This Manual is written and compiled in accordance with the IEC 60601-1 (Medical electrical equipment Part1: General requirements for safety) ,and MDD 93/42/EEC. It complies with both international and enterprise standards and is also approved by the Food and Drug Administration, Ministry of Health and Welfare. The Manual is written for the current Elegant-1100 Multi-parameter Patient Monitor.

The Manual describes, in accordance with the Elegant-1100 Multi-parameter Patient Monitor's features and requirements, main structure, functions, specifications, correct methods for transportation, installation, usage, operation, repair, maintenance and storage, etc. as well as the safety procedures to protect both the user and equipment. Refer to the respective chapters for details.

The Manual is published in English and we have the ultimate right to explain the Manual. No part of this manual may be photocopied, reproduced or translated into another language without the prior written consent. We reserve the right to improve and amend it at any time without prior notice. Amendments will however be published in a new edition of this manual.

All rights reserved.

Marks in the Manual:

-  **Warnings:** must be followed to avoid endangering the operator and the patient.
-  **Notes:** contains some important information and tips about operations and application.
-  **Attentions:** must be followed to avoid causing damage to the monitor.

Instructions to User

Dear Users, thank you very much for purchasing our product. Please read the following pages very carefully before using this equipment.

Read these instructions carefully before using this monitor. These instructions describe the operating procedures to be followed strictly. Failure to follow these instructions can cause monitoring abnormality, equipment damage and personal injury. The manufacturer is NOT responsible for the safety, reliability and performance issues and any monitoring abnormality, personal injury and equipment damage due to user's negligence of the operation instructions. The manufacturer's warranty service does not cover such faults.

WARNING

- Do NOT operate this monitor in the circumstance where flammable gas or explosion factor exists.
- To ensure patient safety, do NOT place the monitor in any position that might cause it to fall on patient.
- The user must check that the equipment functions safely and ensure that it is in proper working condition before being used.
- The device connected to this monitor should be in accordance with IEC 60601-1.
- Please shut down the monitor and remove sensors while during MRI scanning, or else induced current could potentially cause burns. The monitor may affect the MRI image, and the MRI unit may affect the accuracy of monitor measurements.
- Although biocompatibility tests have been performed on all the applied parts, some exceptional allergic patients may still have anaphylaxis. Do NOT apply to those who suffer from anaphylaxis.
- All the cables and rubber tubes of the applied parts should be kept away from the patient's cervix to prevent any possible suffocation of the patient.
- All the parts of the monitor should NOT be replaced at will. If necessary, please use the components provided by the manufacturer or those of the same model and standards as the accessories along with the monitor which are provided by the same factory, otherwise negative effects concerning safety and biocompatibility, etc. may be caused.
- If the monitor falls off accidentally, please do NOT operate it until its safety and

technical indexes have been carefully tested and positive testing results obtained.

- **Before maintenance, please switch off power.**
- **This monitor is a professional medical device, can only be operated by trained personnel with qualification.**
- **Please peruse the relative content about the clinical restrictions and contraindication.**
- **Dispose of the expired device and its accessory according to applicable local regulations.**

CONTRAINDICATIONS

- **It is contraindicated for use on active patients or for prolonged use.**

ADVERSE REACTION

- **Continuous use of fingertip SpO₂ sensor may result in discomfort or pain, especially for those patients with microcirculatory problem. It is recommended that the sensor should NOT be applied to the same finger for over two hours.**

TABLE OF CONTENT

CHAPTER 1 OVERVIEW	1
1.1 FEATURES	1
1.2 PRODUCT NAME AND MODEL	2
1.3 DESCRIPTION AND INDICATION FOR USE	2
1.4 REQUIREMENT OF OPERATING ENVIRONMENT AND INSTALLATION	2
1.5 NORMAL WORKING ENVIRONMENT	2
1.6 IMPACT ON ENVIRONMENT AND RESOURCES	3
1.7 SAFETY	3
CHAPTER 2 THE OPERATION AND THE PATIENT MONITOR	4
2.1 OVERALL STRUCTURE AND WORKING THEORIES	4
2.2 COMPOSITION	4
CHAPTER 3 INSTALLATION AND CONNECTION	5
3.1 PANEL INTRODUCTION	5
3.1.1 Front Panel	5
3.1.2 Left and Right Side Panel	7
3.1.3 Back Panel	8
3.2 INSTALLATION	9
3.2.1 Opening the Box and Check	9
3.2.2 Connecting the AC Power Cable	9
3.2.3 Starting the Monitor	9
3.3 CONNECTION	10
3.3.1 ECG Connection	10
3.3.2 Blood Pressure Cuff Connection	11
3.3.3 To connect the SpO2	12
3.3.4 Battery Installation	13
3.3.5 Loading Printing Paper	13
CHAPTER 4 MONITORING SCREEN	15
4.1 MAIN SCREEN	15
4.1.1 Date and Time Setup	15
4.1.2 Screen Description	16
4.2 DISPLAY2 SCREEN	20
4.2.1 Viewing Screen	20
4.3 FREEZE AND ST ANALYSIS SCREEN	21
4.3.1 Screen Description	21
4.3.2 Operation Instruction	22
4.4 MODE SELECTION SCREEN	22
4.5 SPO2 DATA LIST SCREEN	23

4.5.1 Screen Description.....	23
4.6 TREND SCREEN.....	23
4.6.1 Screen Description.....	23
4.6.2 Operating Instructions.....	25
4.7 RECALL SCREEN.....	26
4.8 THE MENU SETUP SCREEN OF THE SYSTEM.....	28
4.8.1 Screen Description.....	28
4.8.2 System Parameter Settings.....	30
4.8.3 ECG Parameter Settings.....	30
4.8.4 NIBP Parameter Settings.....	31
4.8.5 SpO2 Parameter Settings.....	32
4.8.6 Reset.....	32
4.9 COLOR SETTINGS SCREEN.....	32
4.10 FILE/PATIENT MANAGEMENT SCREEN.....	33
CHAPTER 5 TECHNICAL SPECIFICATIONS.....	34
5.1 ECG MONITORING.....	34
5.2 NIBP MONITORING.....	35
5.3 SPO2 MONITORING.....	35
5.4 PULSE RATE MONITORING.....	35
5.5 DATA RECORDING.....	35
5.6 OTHER TECHNICAL SPECIFICATIONS.....	35
5.7 CLASSIFICATION.....	35
5.8 DEFAULT ALARMING VALUES OF ALL PARAMETERS.....	36
CHAPTER 6 PACKAGING AND ACCESSORIES.....	37
6.1 PACKAGING.....	37
6.2 ACCESSORIES.....	37
CHAPTER 7 MONITORING PARAMETERS.....	38
7.1 MEASURING ECG.....	38
7.2 THE PRINCIPLE FOR MEASUREMENT OF THE BLOOD PRESSURE.....	39
7.2.1 Comparison between Blood Pressure Measuring Methods.....	39
7.3 MEASURING THE BLOOD PRESSURES.....	41
7.3.1 Operational Tips.....	41
7.3.2 Clinical Limitations.....	41
7.4 MEASURING THE PULSE OXYGEN SATURATION AND PULSE RATE.....	43
7.4.1 Operational Tips.....	43
7.4.2 Clinical Limitations.....	43
CHAPTER 8 MAINTENANCE.....	44

8.1 PROTECTIVE MAINTENANCES.....	44
8.2 BATTERY MAINTENANCE.....	44
8.3 CLEANING, STERILIZATION AND DISINFECTION OF THE MONITOR.....	45
8.4 CLEANING, STERILIZATION AND DISINFECTION OF ACCESSORIES.....	45
8.5 STORAGE.....	46
8.6 TRANSPORTATION.....	46
CHAPTER 9 TROUBLESHOOTING.....	47
9.1 NO DISPLAY ON THE SCREEN.....	47
9.2 EXCESSIVE ECG SIGNAL INTERFERENCE OR THICK BASELINE.....	47
9.3 NO BLOOD PRESSURE AND PULSE OXYGEN MEASUREMENTS.....	47
9.4 SYSTEM ALARM.....	47
CHAPTER 10 APPENDIX.....	48
10.1 OTHER TERMS AND MESSAGES.....	48

Chapter 1 Overview

1.1 Features

This monitoring system may be used to monitor patient's ECG, non-invasive blood pressure (NIBP), pulse oxygen saturation (SpO₂), pulse rate and other physiological parameters.

- ✧ 10.4" high-resolution color LCD to display patient's ECG waveform and SpO₂ cubage waveform;
- ✧ Abundant and friendly display interface, multifold ECG display screen:
 - Main monitoring screen:* displays the information of all the waveforms and parameters visually.
 - Observing screen:* heart rate value and SpO₂ value display in big fonts, displays an ECG waveform and a SpO₂ cubage waveform at the same time.
- ✧ Storage and recall of a list of 400 groups of NIBP measurement data, as well as heart rate and SpO₂/pulse rate when the measure of blood pressure is taken;
- ✧ Nonvolatile 6hours of ECG data storage and recall;
- ✧ High precision NIBP measuring module, good repeat capability;
- ✧ Software and hardware-dual excess air pressure protection function;
- ✧ Special SpO₂ measuring device, which ensures the accuracy of SpO₂ and pulse rate measures;
- ✧ Unique file management, which enables recording, modifying, deleting and saving operation of patient's information.
- ✧ Precise alarm system, different alarm events adopt different alarm degrees; 3 degrees visual and audible alarm function;
- ✧ Flexible high and low alarm limits setting function;
- ✧ Resistance against defibrillator and electrosurgical knife interference; Cardiac pacemaker restraining function enables to be used along with cardiac pacemaker;
- ✧ Blood pressure may be measured in the mode of "adult/pediatric", which may be selected via the menu, to better suit the adult and pediatric patient;
- ✧ Built-in printer (optional) to output waveforms and text;
- ✧ Networking with the central station as a part of the central network;
- ✧ Easy to Color-code and change the color of the font, background and waveforms if needed;
- ✧ Battery power indicator, which enables near real-time battery power detection and displays the battery power.

1.2 Product Name and Model

Name: "North-vision" Multi-parameter patient monitor

Model: Elegant-1100

1.3 Description and Indication for use

1.3.1 Device Description

Elegant-1100 is intended to monitor, display and record physiological data to provide cardiac and vital signs monitoring within a medical facility. It is modular designed patient Monitor, which can monitor the patient's Electrocardiograph (ECG) by measuring physical parameters with variety modules. Also, It can measure non-invasive blood pressure (NIBP) including systolic, diastolic and mean as well as detect the blood oxygen saturation (SpO₂) and pulse rate (PR).

The accessories and the sensors will transfer the physical parameters into electrical signals, which can be collected and amplified by the circuit in the device. After CPU analyzing and calculating the parameters are displayed on the screen in a graphical representation and it can record and/or print if necessary. The device may generate audible and/or visual alarm when a measured rate falls outside preset limits.

1.3.2 Indication for use

North-vision Elegant-1100 of Multi-parameter Patient Monitor is intended to monitor, display and record physiological signs of adult, pediatric patients. With the functions of near real-time recording and displaying parameters ECG, heart rate, non-invasive blood pressure, blood oxygen saturation and pulse rate, it allows comprehensive analysis of patient's physiological conditions.

This apparatus is applicable for use in hospitals, clinics, and practitioner's office. The operation should be carried out by qualified professionals only.

1.4 Requirement of Operating Environment and Installation

1. This device should be situated in a place protected against direct sunlight, so as to prevent overheating inside the equipment.
2. Do not use this device in an environment with toxic or inflammable gas.
3. This device should be fixed on a stand or flat platforms, so as to prevent possible shock.
4. Do not use with any equipment other than those expressly permitted in these instructions.
5. When using this device with electrosurgical equipment, the user (doctor or nurse) should pay attention to the safety of patient.
6. Make sure that the equipotential grounding terminal is grounded correctly.

1.5 Normal Working Environment

1. Ambient temperature range: 10°C ~40°C
2. Relative humidity: ≤80%
3. Atmospheric pressure: 86kPa ~106kPa

4. Power supply: a.c.100~240V

5. Power frequency: 50/60Hz

1.6 Impact on Environment and Resources

Low

1.7 Safety

- a) Conform to IEC 60601-1, certified as Class II, with Type BF and CF applied parts.
- b) Elegant-1100 Multi-parameter Patient Monitor can resist against defibrillator and electrosurgical equipment interferences, and can detect and filter the pacemaker-generated signals;

Chapter 2 The Operation and the Patient Monitor

2.1 Overall Structure and Working Theories

The overall structure of this monitor is shown as Fig.2.1.

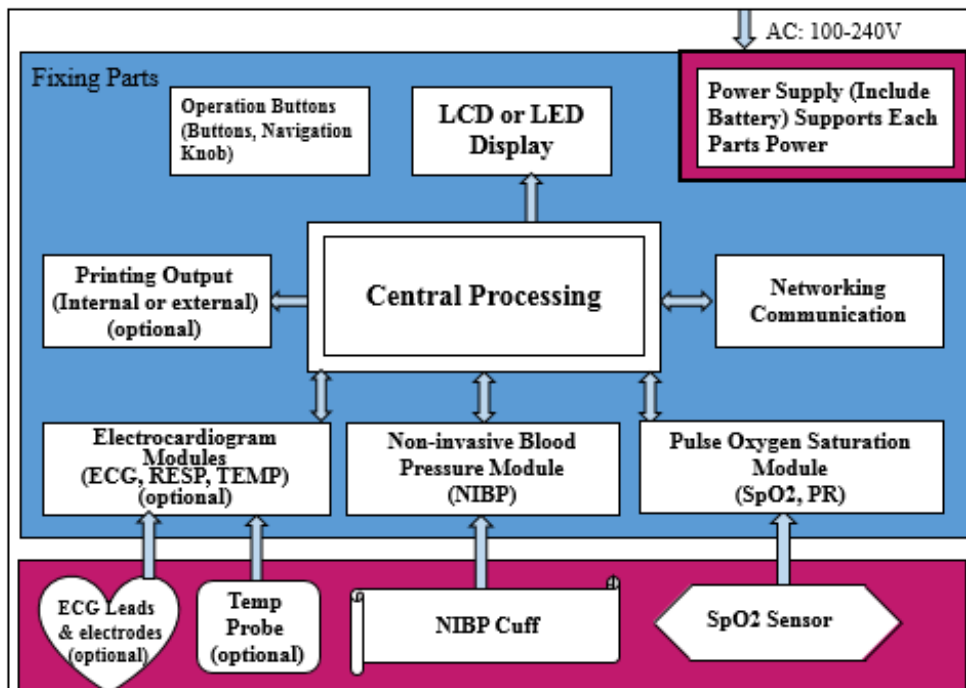

Elegant-1100 patient monitor is a product of modular design. It performs its measurement of the physiological parameter through different modules. There are four functional modules for the monitor: ECG module, NIBP module, SpO₂ module and Central Processing Unit (CPU) module.

1. ECG module collects heart rate through the ECG leads.
2. SpO₂ module collects data for pulse rate, pulse oxygen saturation (SpO₂) and SpO₂ volume waveform via the SpO₂ probe.
3. NIBP module collects blood pressure data, including the diastolic, systolic and mean arterial pressure through the NIBP cuff. The cuffs are sized for adult, pediatric. NIBP measure has three modes: adult, and pediatric mode.
4. CPU module consists of main board, multi-function board, and the keyboard. The multi-function board performs the data communication between the main board, ECG module, SpO₂ module and NIBP module.

2.2 Composition

1. The monitor consists of the main unit and the corresponding functional components (ECG leads, non-invasive blood pressure cuff, and SpO₂ probe).
2. The monitor has 4 measurement channels: ECG, NIBP channel, SpO₂ and pulse channel.
3. The monitor has two output channels: networking communication port and printer.
4. Basic parameters include: heart rate, NIBP, SpO₂, pulse rate.

Chapter 3 Installation and Connection

3.1 Panel Introduction

3.1.1 Front Panel

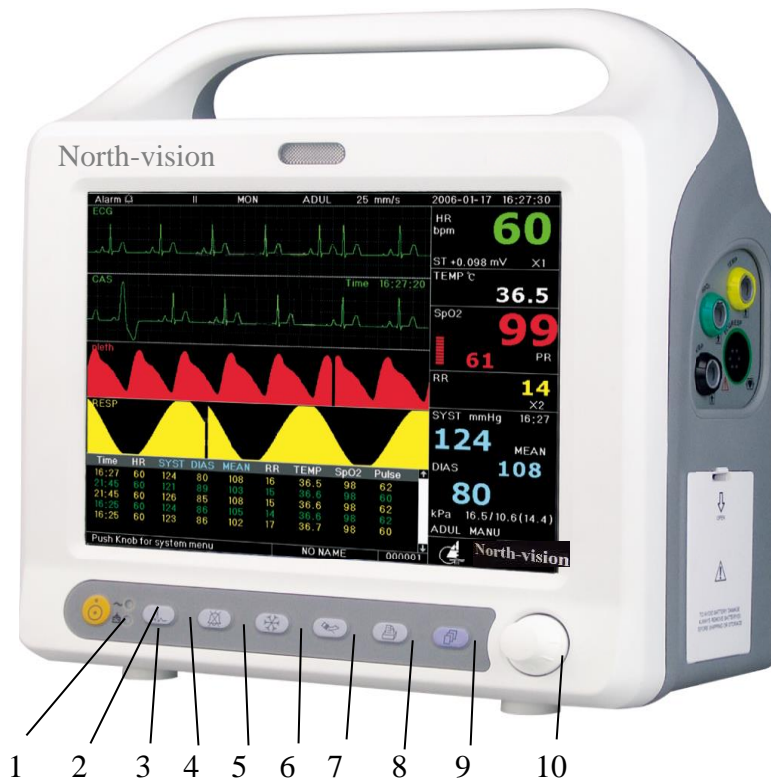

Figure 3.1 Elegant-1100 Front Panel

The patient monitor front panel is shown above:

1 Power switch

Press it to turn on the monitor, press it again to turn off the monitor.

2 ~: AC power indicator

When AC indicator is on, it means this device is using mains power supply.

3 : DC build-in battery indicator

When DC indicator is on, it means the battery is being used; when both of AC indicator and DC indicator light are on, it means that this device is using mains power supply and the battery is being recharged.

4 LEAD switch

Click it to shift the ECG monitoring circulatory among I , II , III , aVR , aVL , aVF , V and GND.

5 ALARM

Press this key to setup the alarm function.

In monitoring screen, press this key to set the alarm silent time. The time shows on the upper left corner. The

system starts count-down after the alarm silent time is set and will activate the alarm when the count-down ends.

The alarm silence time has 4 settings: 2 min, 5 min, 10 min and 20 min, or in alarm.

6 FREEZE

Press this key to freeze ECG wave, or ECG, SpO₂ based on the freezing settings in the system.

It also enters the ST segment manual analysis screen.

7 NIBP

Press this key to start NIBP measurement. Press it again to stop the measurement.

8 PRINT

Press this key to print different waveforms on different screens.

In the main screen, archive/file management screen, color setting screen, it prints the ECG waveform, SpO₂ waveform.

In the NIBP data-listing screen, it prints the NIBP data list.

In the SpO₂ data- listing screen, it prints the SpO₂ data list.

In the Trend screen, it prints the system trend graph.

In the System menu, it prints the system parameter settings.

In the Recall screen, it prints the Recalled data list or prints current lead's ECG waveform and Recalled waveform.

9 DISP (Display)

Press this key to switch between initial monitoring screen and Observe Screen, and press it to return to the main screen from other screens.

10 Navigation Knob

By rotating the navigation knob, the operator can choose the function and parameters. By pushing down and releasing the knob, the operator can switch screen, confirm operations.

The majority of the operations of the monitor are performed by using navigation knob.

11 Alarm indicator

Indicator Color	Alarm Level	Alarm Event
Red flashing	High priority alarm	Exceeding the limits, pulse stop or suffocation
Orange flashing	Middle priority alarm	Leads and probe off, VE RONT and SVE RONT
Orange light	Low priority alarm	Other arrhythmia phenomenon
Green light	Normal	

3.1.2 Left and Right Side Panel



Figure 3.2 Left panel Figure



3.3 Right panel



The built-in printer is on the left panel as shown in Figure 3.2.

The right panel of the monitor hosts the patient cable and probe jacks, as shown in Figure 3.3.

1. **NIBP** - NIBP measuring cuff jack
2. **SpO₂** - SpO₂ probe jack
3. **ECG** - ECG leads jack

4.  Battery cover, remove the cover to install or change rechargeable battery. Factory default: two rechargeable batteries (12V 2.3Ah); battery specification: FB 12V 2300mAh.

“TO AVOID BATTERY DAMAGE, ALWAYS REMOVE BATTERY(S) BEFORE SHIPPING OR STORAGE”

-  With Type BF applied part
-  With Type CF applied part and applicable during the defibrillator is used.
-  Caution! Please read the manual for details.

3.1.3 Back Panel



Figure 3.4 Back panel

The back panel of the monitor includes the following

1. **MONITOR:** External monitor port
2. **NET:** Communication port which is used to network with central monitoring system
3.  : Equipotential grounding port
4. **FUSE 2 X T6.3A:** Fuse holder; fuse specification: T6.3AL/250V $\Phi 5 \times 20$ mm
5. **AC 100V~240V:** Power supply socket
6. **S/N:** Serial Number
7. **Nameplate**

3.2 Installation

3.2.1 Opening the Box and Check

1. Open the packaging, take out the monitor accessories from the box carefully and place it in a safe stable and easy to watch position.
2. Open the users' manual to sort the accessories according to the packing list.
 - ◆ Inspect the accessories for any mechanical damages
 - ◆ Check all the exposed leads and inserted accessories

Please contact the local dealer or our company in case of any problems. We are to offer you the best solution for your satisfaction.

3.2.2 Connecting the AC Power Cable

Connecting procedures:

- ◆ Make sure that the AC power supply is 100-240Vac, 50/60Hz.
- ◆ Use the power cable prepared by the manufacturer. Insert one end of it to the power port of the monitor and the other end to the grounded three-phase power jack.
- ◆ Connect the monitor to the grounding port with the provided ground cable.

Caution: ensure that the monitor is grounded correctly.

-  **The provided battery of the monitor must be recharged after transportation or storage. So if the monitor is switch on without being connected to the AC power socket, it may not work properly due to insufficient power supply.**

3.2.3 Starting the Monitor

The system performs self-detection and enters initial display after switch on the monitor, and the orange alarm indicator blinks to inform that the user can begin operating it.

- ◆ Check all the applicable functions to make sure that the monitor works normally.
- ◆ If the built-in battery is applied please recharge it after using the monitor to ensure sufficient power storage.

-  **Do not use the monitor to monitor the patient if there are indications of damage or reminders of error. Please contact the local dealer or our company.**

-  **Start the monitor again 30 seconds later after it is switched off.**

3.3 Connection

3.3.1 ECG Connection

ECG measurement is to collect the ECG signal via the ECG electrodes. Electrode connects the patient and the lead. The lead connects the monitor. The locations of the electrodes are very important for obtaining accurate ECG signals.

1. Connect the cable to the right-panel connector marked with the ECG icon.
2. Select electrodes to be used. Use only one type of electrode on the same patient to avoid variations in electrical resistance. For ECG monitoring, it is strongly recommended to use silver/silver chloride electrodes. When dissimilar metals are used for different electrodes, the electrodes may be subject to large offset potentials due to polarization. Using dissimilar metals may also increase recovery time after defibrillation.
3. Prepare the electrode sites according to the electrode manufacture's instructions.

The locations of the electrode are in the following Figure:

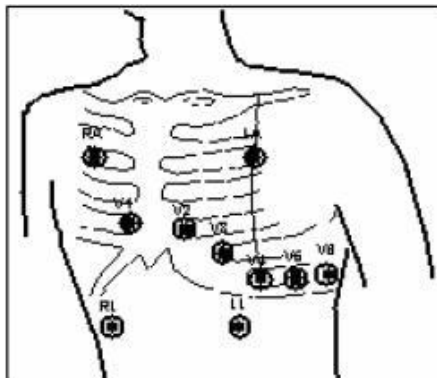



Figure 3.5 Locations of Electrodes

Note: If skin rash or other unusual symptoms develop, remove electrodes from patient.







4. After starting the monitor, if the electrodes become loose or disconnected during monitoring, the system will display “LEAD OFF” on the screen to alarm the operator.

 **It might not display ECG wave with 3 leads. The 5 leads should be used to have ECG wave.**

5. The ECG leads and their corresponding locations are as follows:

Symbol		Position
	RA	The intersection between the centerline of the right clavicle and Rib 2
	LA	The intersection between the centerline of the left clavicle and Rib 2
	LL	Left part of the upper abdomen
	RL	Right part of the upper abdomen
C (V) Chest electrode	C1(V1)	The electrodes are placed in different places, the different lead forms will display.
	C2(V2)	
	C3 (V3)	
	C4 (V4)	
	C5 (V5)	
	C6 (V6)	

Safety Instructions for ECG Monitoring



-  Elegant-1100 Multi-parameter Patient Monitor can only be equipped with ECG leads provided by our company; using ECG leads supplied by other companies may cause improper performance or poor protection while using defibrillator.
-  Electric parts of electrodes, leads and cable are forbidden to contact any other conductive parts (including ground).
-  Elegant-1100 Multi-parameter Patient Monitor can resist against defibrillator and electrosurgical unit. Readings may be inaccurate for a short time after or during using defibrillator or electrosurgical unit.
-  Transient caused by cable circuitry blocks while monitoring may be similar to the near real heartbeat waveform, as a result resistance heart rate alarm rings. If you put the electrodes and cable in proper places according to this manual's instructions and the instructions for using electrode, the chance of this transient occurring will be decreased.
-  To the patient with pacemaker, due to that this device has been designed to provide resistance to pacemaker signal interference, generally the pacemaker pulse is not counted in heart rate measurement and calculation, but when the cycle time of pacemaker pulse is over 2ms, it may be counted. In order to reduce this possibility, observe the ECG waveforms on the screen carefully and do NOT rely entirely on the heart rate display and alarm system of this monitor when monitoring this kind of patients.
-  Besides the improper connection with electrosurgical unit may cause burns, the monitor may be damaged or arouse deviations of measurement. You can take some steps to avoid this situation, do NOT use small ECG electrodes, choosing the position which is far away from the estimated Hertzian waves route, using larger electrosurgical return electrodes and connecting with the patient properly.
-  ECG leads may be damaged while using defibrillator. If the leads are used again, please do the functional check first.

3.3.2 Blood Pressure Cuff Connection

1. Connect the cable to the right-panel connector marked with the NIBP icon.
2. Select a cuff of appropriate size according to the age of the subject. Its width should be 2/3 of the length of The upper arm. The cuff inflation part should be long enough to permit wrapping 50-80% of the limb concerned. See the table below for the dimensions:

Note: The size of the cuff selected should suit the subjects while measuring.

Cuff Model	Arm Circumference	Cuff Width
Small-sized Pediatric Cuff	12cm ~ 19cm	11cm
Child Cuff	18cm ~ 26cm	8.4cm
Adult Cuff	25cm ~ 35cm	14cm
Large-sized Adult Cuff	33cm ~ 47cm	17.4cm

-  Prior to use of the cuff, empty the cuff until there is no residual air inside it to ensure accurate measurement.
-  When putting on the cuff, unveil and wrap it around the upper arm evenly to appropriate tightness as shown below.

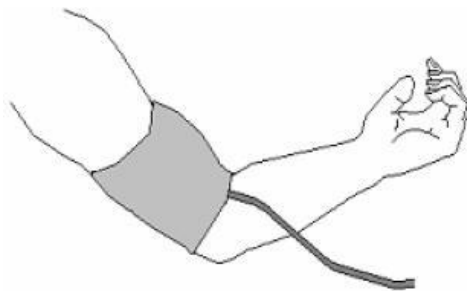







Figure 3.6 Cuff Position

 **When unplugging the cuff, hold the head of the connector and pull it out.**

Safety Instructions for NIBP Monitoring

-  When taking the measure of an pediatric's (less than 10 years old) blood pressure, do NOT operate in the adult mode. The high inflation pressure may cause lesion or even body putrescence.
-  It is recommended to take the blood pressure measurement manually. Automatic measurement should be used at the presence of a doctor/nurse.
-  NIBP monitoring is prohibited to those who have severe hemorrhagic tendency or with sickle cell disease, or partial bleeding will appear.
-  Do NOT bind NIBP cuff on limbs with transfusion tube or intubations or skin lesion area, otherwise, damages may be caused to the limbs.
-  Pay attention to the color and sensitivity of the limb when measuring NIBP; make sure the blood circulation is not blocked. If blocked, the limb will discolor, please stop measuring or remove the cuff to other positions. Doctor should examine this timely.
-  Do NOT twist the cuff tube or put heavy things on it.

3.3.3 To connect the SpO₂

SpO₂ probe is very delicate equipment. Please follow the steps and procedures in operating it. Failure to operate it correctly can cause damage to the SpO₂ probe.

Operation procedure:

1. Connect the SpO₂ probe to the right panel's jack labeled "SpO₂". **When unplugging the probe, be sure to hold the head of the connector and pull it out.**
2. Insert one finger into the probe (index finger, middle finger or ring finger with proper nail length) according to the finger mark on the probe, shown as below.

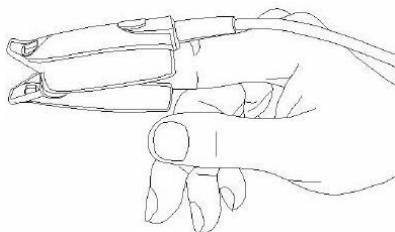











Figure 3.7 Demonstration of SpO₂ Probe

The scenario above will cause inaccurate reading or no readings during SpO₂ measurement.

Safety Introductions for SpO₂ Monitoring

-  Continuous use of fingertip SpO₂ sensor may result in discomfort or pain, especially for those patients with microcirculatory problem. It is recommended that the sensor should NOT be applied to the same finger for over two hours.
-  SpO₂ measuring position must be examined more carefully for some special patient. Do NOT install the SpO₂ sensor on the finger with edema or fragile tissue.
-  Do NOT put the SPO₂ sensor and pressure cuff on the same limb, otherwise the NIBP measuring will affect SpO₂ measuring and cause the alarm error.
-  Do NOT use the damaged SpO₂ sensor.
-  The SpO₂ sensor can not be immersed into water, liquor or cleanser completely, because the sensor has no capability of waterproofness.
-  Please do not allow the cable to be twisted or bended.
-  Please do not use nail polisher or other cosmetic product on the nail.
-  The finger should be of normal length.

3.3.4 Battery Installation

1. Make sure that monitor doesn't connect to mains power supply and stays in switch-off status.
 2. Open the battery cover, insert the battery into any slot of battery compartment, and pay attention to the instruction of polarity direction in the compartment. Do not reverse the battery.
 3. Move baffle plate with hand to fasten the battery.
 4. Remove the battery cover. (According to your need, you can insert one more storage battery to prolong using time.)
-  Please take out the battery from battery compartment, if it won't be used for a long time.

3.3.5 Loading Printing Paper

This description is for loading paper for the built-in printer.

Operation procedures:

1. Press both "OPEN" notches with force on printer shield with two thumbs to open it.
2. Move the tab of rubber roller lock at the left 90° upwards to unlock it.
3. Cut one end of the paper into triangle, and load the paper from the underside of the rubber roller.
4. Turn the roller clockwise to get the paper rolled, and put the paper roll into the compartment.
5. Pull the paper out of paper slot on the shield.
6. Move the tab of the rubber roller lock 90° downwards to lock it.
7. Put the shield back in position and secure it.

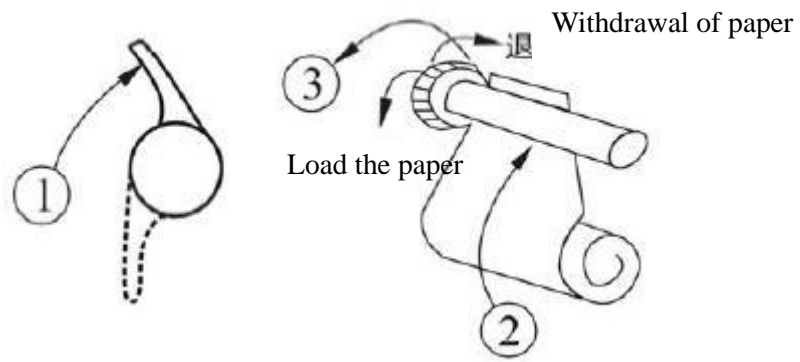

Figure 3.8 Loading Printing Paper

Chapter 4 Monitoring Screen

4.1 Main Screen

4.1.1 Date and Time Setup

Instead of entering into monitoring screen, it shows the date and time setting screen immediately after the monitor is started, shown as Figure 4.1:

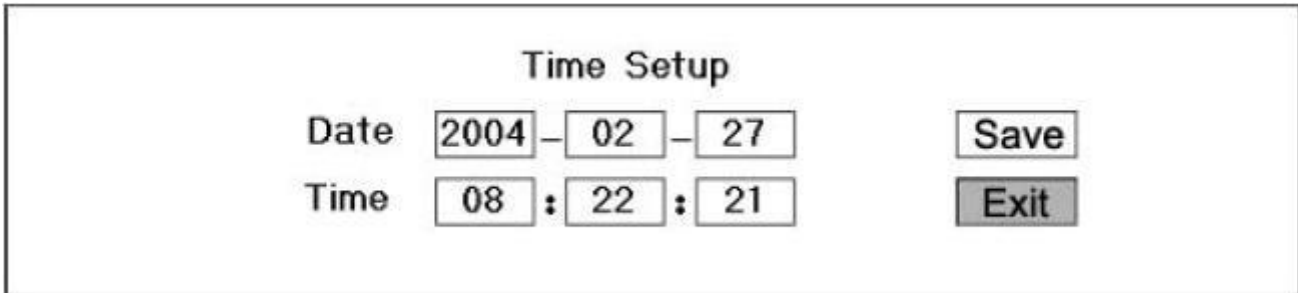

The screenshot shows a 'Time Setup' screen with the following layout:

Time Setup						
Date	2004	-	02	-	27	Save
Time	08	:	22	:	21	Exit

Figure 4.1 Date and Time Setup

The system will stay on this screen for 10 seconds. If you do not rotate the navigation knob within this period, the screen will enter into the Main Screen.

Follow the steps below to set date and time.

Step 1: Rotate Navigation Knob, move the gray cursor to “Edit”.

Step 2: Press the knob, and then gray cursor stays on the Year of the date. Press the knob again and the gray cursor becomes highlighted. Rotate the knob left or right to increase or decrease the year value.

Step 3: When the Year is set, press the knob to move the gray cursor to the Month of the date.

Step 4: Repeat Step 2 and Step3 to adjust the Year, Month, Date, Hour and Minute.

Step 5: If you have finished adjusting the date and time, press the knob and rotate the knob to move the cursor to “Save”, press it to save the settings. Then move the cursor to “Exit”, press it to exit the date and time setting screen, meanwhile enter into the main screen shown in Figure 4.2.

The system is initialized and enters into Main Screen where monitoring and system operation are performed. (shown in Figure 4.2)

4.1.2 Screen Description

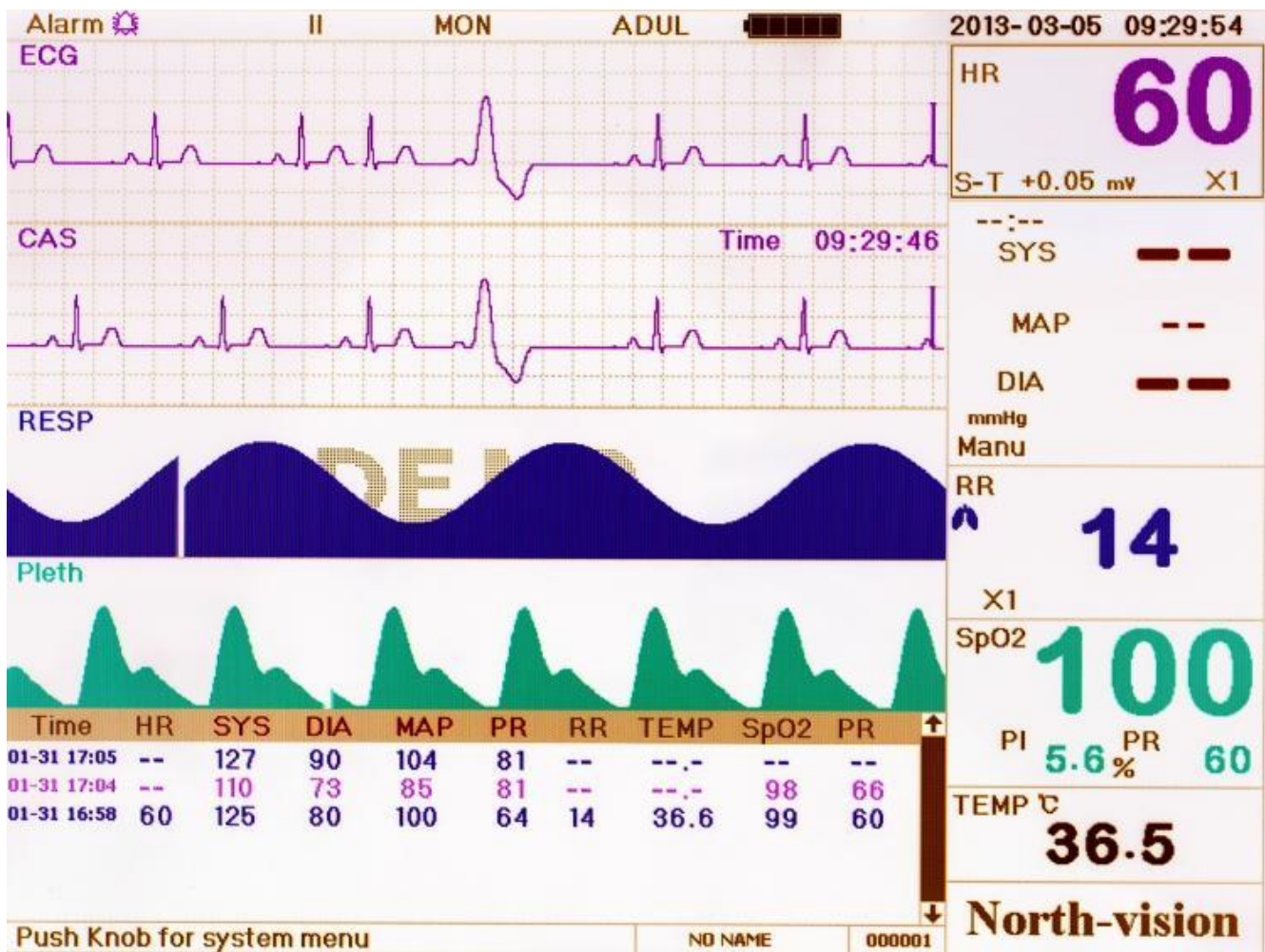



Figure 4.2 Main Screen

Border area:

- ✧ **“Alarm”**: Alarm status, shows the alarm ON, shows the alarm silence status. “16:27”: alarm silence count down time, the alarm activates automatically after the system finishes counting down.
- ✧ **“II”**: Lead indicator, I, II, III, aVR, aVL, aVF, V (V1-V6) and GND adjustable.
- ✧ **“MON”**: ECG Filter type. There are “Diagnosis”, “Monitor”, and “Operation” three types. The option can be set in the system menu.
- ✧ **“Adult”**: The type of the monitor subject.
- ✧ : battery power indicator; when the indicator is yellow and displays only one “grid”, it means there is a little battery power left. When the indicator turns red and blinks, as well as less than one “grid” displays, meanwhile, the system alarm will be on to remind the battery shortage. Please connect the device to the mains power supply in time to ensure the normal use of this monitor, and the battery will be recharged. When the battery power is full, battery power indicator displays full grid. During recharging, the grids in the battery indicator are rolling circularly.
- ✧ **“2013-03-05 09:29:54”**: System current time and date. The current Figure shows the time and date of March 05th, 2013, 09:29:54.

- ✧ **“Push knob for system menu”**: System prompt or description for the current status.
- ✧ **“NO NAME”**: Patient name. The patient name can be entered or changed in the archive management window.
- ✧ **“000001”**: The patient ID. The patient ID can be entered or changed in the archive management window.

Waveform area:

- ✧ 1st Waveform: The first waveform is ECG waveform.
- ✧ 2nd Waveform: The second waveform is cascade of the first ECG waveform. Notice the second waveform is displayed screen by screen, instead of continuous display in 1st waveform. The 2nd waveform time “09:29:46” is displayed on the upper right corner on the 2nd waveform.
- ✧ 4th waveform: SpO₂ plethysmograph

Data area:

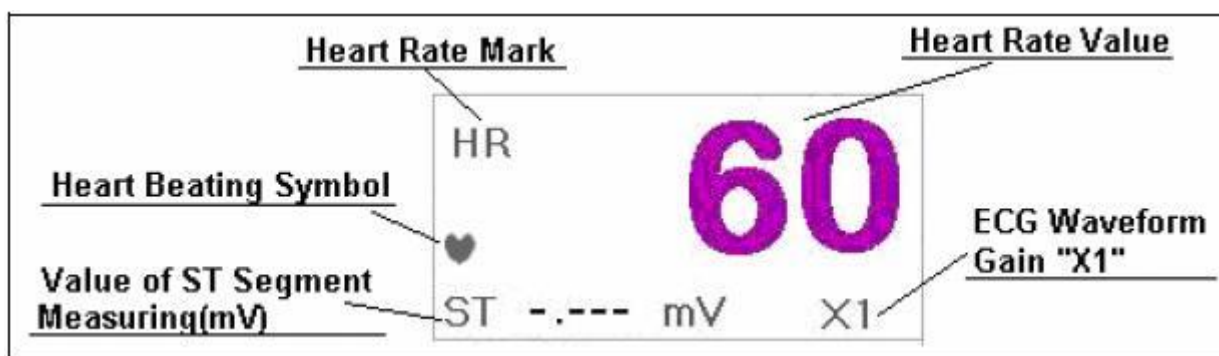



Figure 4.3 Heart Rate Data Area

- ✧ **“HR”**: Indicates the current display is heart rate. The 60 on the right side is the heart rate measured.
- ✧ **“”**: The heart- beating symbol. Its flashing corresponds to the R wave of the ECG waveform. The speed is the same as the heart rate.
- ✧ **“ST -.-.- mv”**: The measured milli-volts value during ST measurement.
- ✧ **“x1”**: ECG waveform gain (amplification), 5 options available
 - “Auto” Automatic waveform gain.
 - “x1/2” half size of the basic waveform
 - “x1” Basic waveform
 - “x2” Twice the size of the basic waveform
 - “x4” Four times the size of the basic waveform

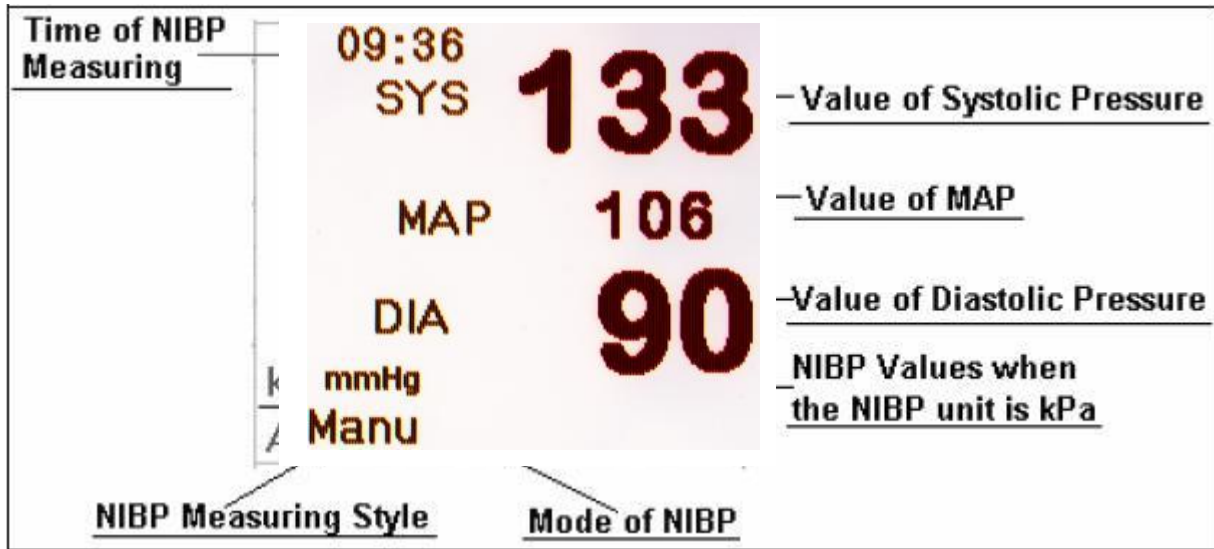

Figure 4.4 NIBP data area

NIBP Data:

- ✧ “SYS”, “DIA”, “MAP”: The blood pressure type labels and the measured value.
- ✧ “09:36”: The time of NIBP measuring
- ✧ “mmHg”: The measurement values when the unit is mmHg.
- ✧ “Manu”: The NIBP measurement mode: Manual mode.

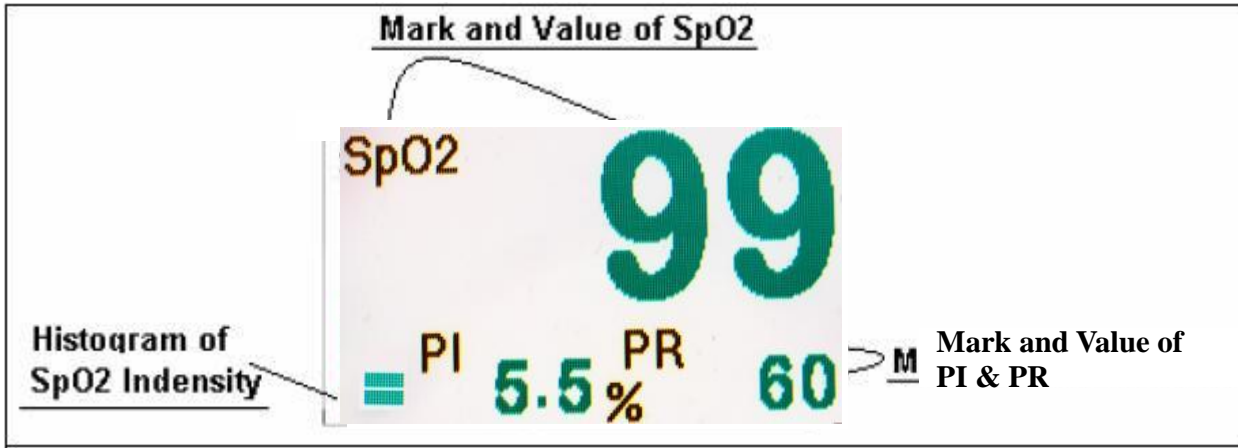



Figure 4.6 SpO₂ and Pulse Rate Data Area

- ✧ “SpO₂”: SpO₂ label, the “99” on the right side is the current SpO₂ value being measured.
- ✧ “PI & PR”: Pulse rate label. The value “5.5 & 60” in the lower left shows the Perfusion index and pulse rate value.

- ✧ “”: SpO₂ strength bar.

NIBP List:

Below the operating area is the data list area, as shown in Figure 4.8.

Time	HR	SYS	DIA	MAP	PR	RR	TEMP	SpO ₂	Pulse
09:21	60	129	81	108	64	14	36.6	98	62
09:21	60	129	81	105	61	14	36.6	99	60
09:20	60	124	83	100	62	16	36.7	98	61
09:20	59	123	89	105	62	14	36.6	98	61

Figure 4.8 NIBP List Area

The time stamp is the time when the NIBP measurements are taken. The data lists here are different under different operating mode. As shown in Figure 4.8, one screen of the data list can list up to 6 groups of data. When there are more than 6 groups of data, we can rotate the navigation knob to scroll the complete list.

4.2 Display2 Screen

4.2.1 Viewing Screen

Choose Obsev of Disp2 on system setup screen, press the DISP key to enter the monitoring screen, as shown in Figure 4.9.

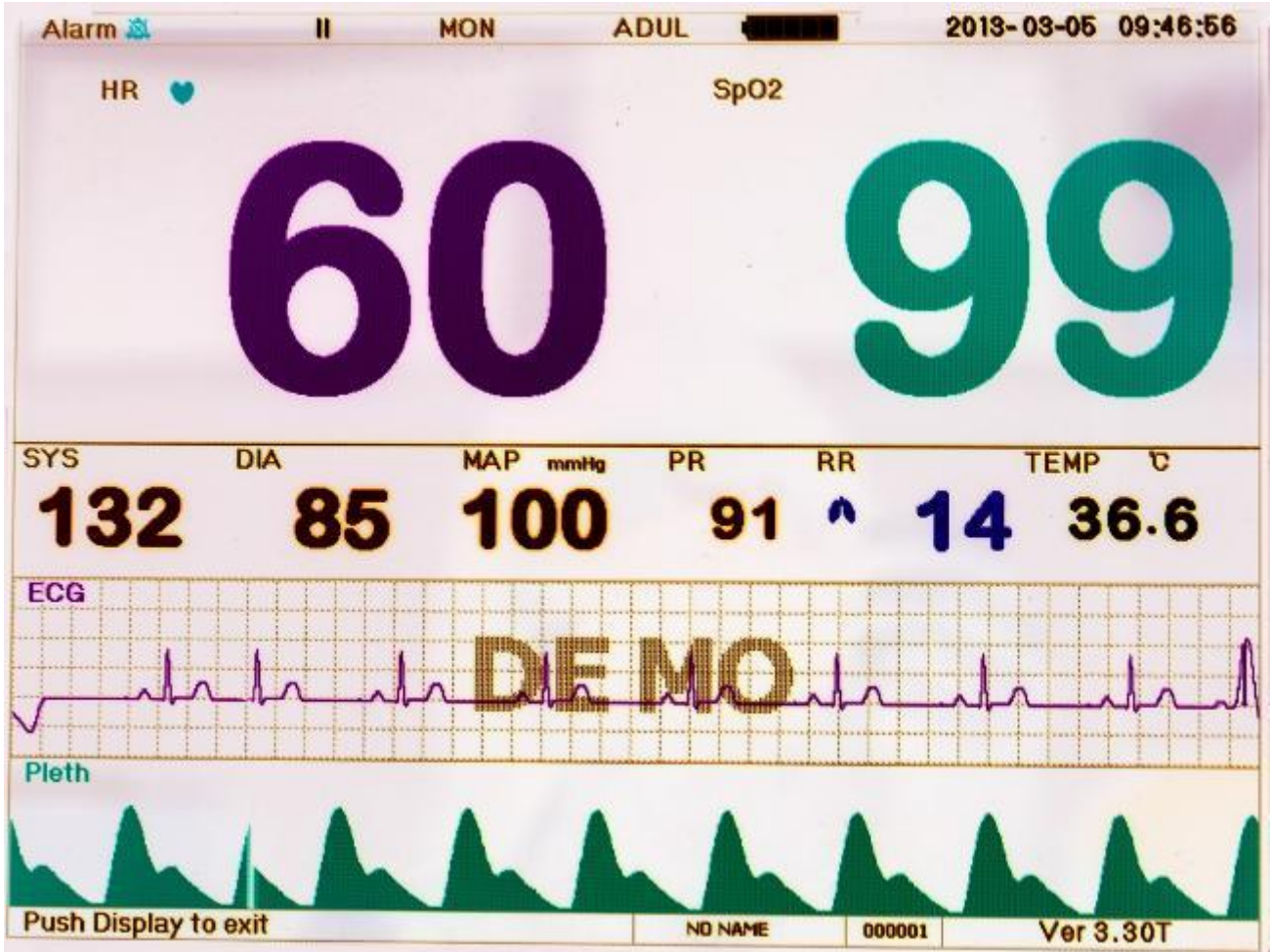

Figure 4.9 Viewing Screen

In this screen, press the DISP key to switch the ECG lead, or press the Print key to print the ECG waveform and the second waveform. The second waveform can be selected in the System menu.

4.3 Freeze and ST Analysis Screen

In the main screen, press the Freeze key to freeze three channel ECG waveforms or all the waveforms on the screen, as shown in Figure 4.10.

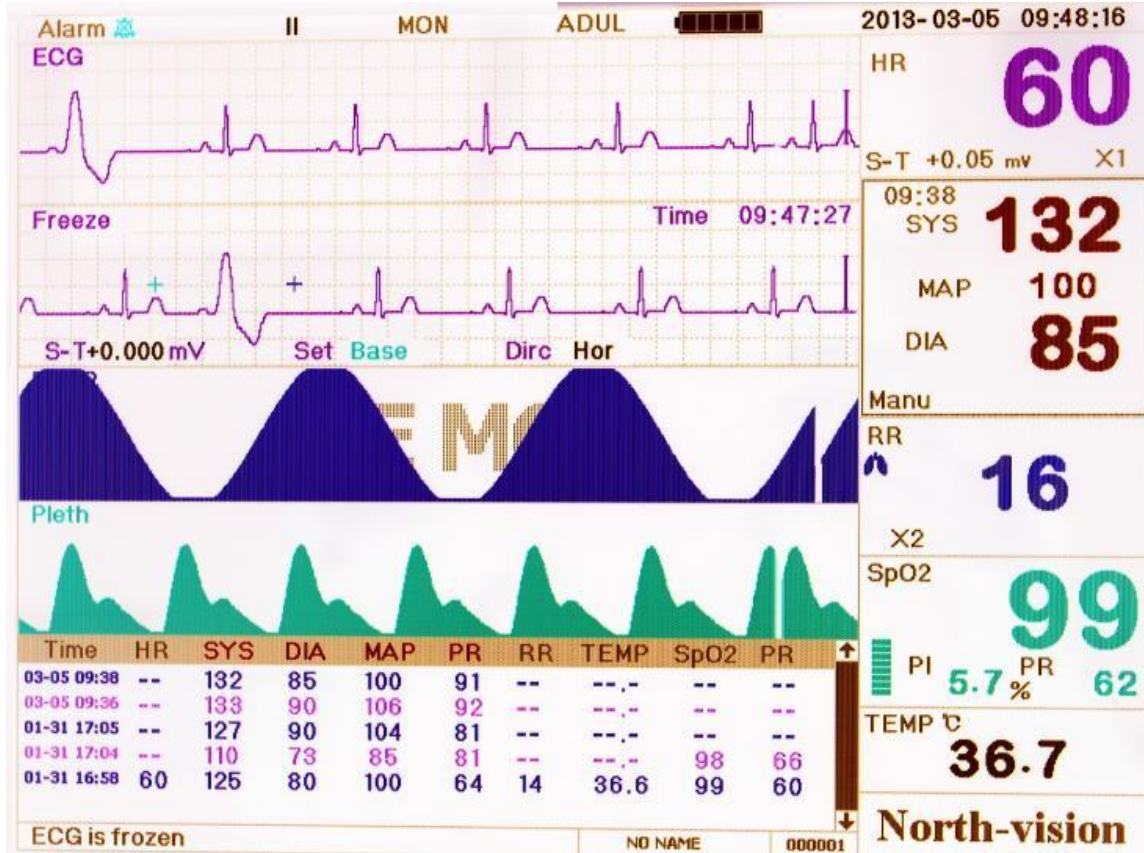

Figure 4.10 Frozen Screen

4.3.1 Screen Description

Freezing, ST segment analysis screen is similar with the main screen, except the waveforms are frozen. For example, the Figure 4.11 is a portion of the frozen waveform. The symbols on the screen were described briefly on the screen.

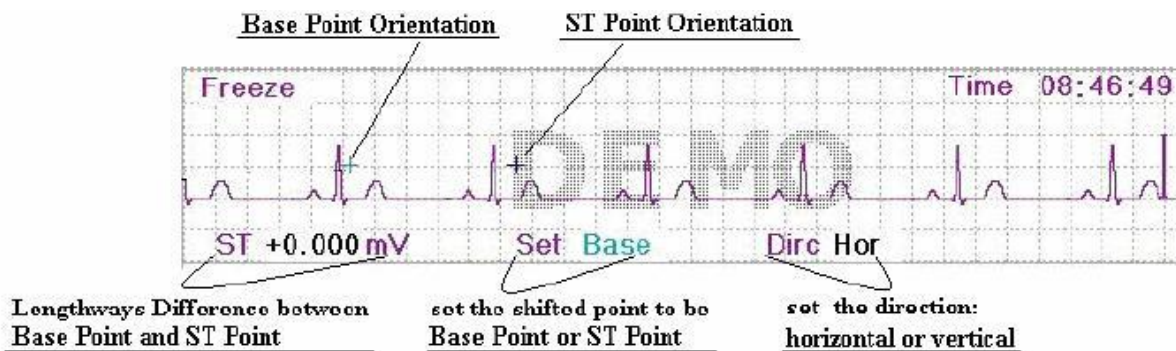

Figure 4.11 Frozen Waveform

When the system setting for the freezing waveform is “ALL”, the Freeze key will freeze all the waveforms.

4.3.2 Operation Instruction

between the ST segment value and the referenced value. The value is displayed after the measure on “ST + 0.000 mV”. The operation is carried out in 4 steps.

First, rotate the Navigation Knob to move the base point (the red cross) horizontally to base line point (the base line is between the Q wave and the P wave). At this point, the frozen screen shows “ST+0.xxx mV, Set Base, Dirc Hor”.

Second, press the Navigation Knob. The screen shows “ST+0.xxx mV, Set Base, Dirc Ver”. Then rotate the knob to move the base point vertically to the base line point.

Third, press the Navigation Knob again. The screen shows “ST+0.xxx mV, Set STDot, Dirc Hor”. Rotate the knob to move the ST point (the yellow cross) horizontally to the point to be measured on the ST segment.

Last, press the Navigation Knob again. The screen shows “ST+0.xxx mV, Set STDot, Dirc Ver”. Rotate the knob to move the ST point vertically to the point to be measured on the ST segment.

One the main screen allows pressing the freeze key to enter the ST segment analysis screen.

NOTE: The S point is the end point of S wave, and the T point is the start point of T wave.

4.4 Mode Selection Screen

Press the Navigation Knob in the main screen as shown in Figure 4.2, the operating area shows the mode selection screen, as shown in Figure 4.12.

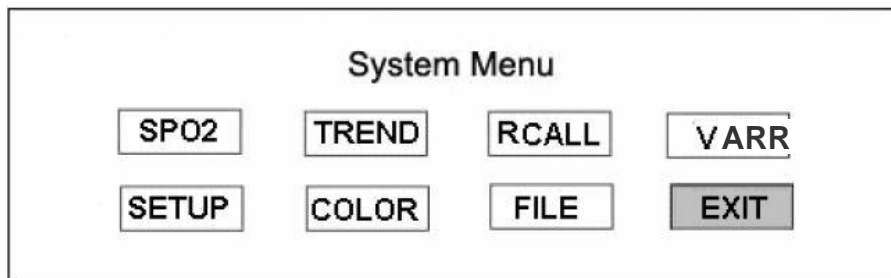

Figure 4.12 Trend Menu Screen

In the mode selection screen, rotate the knob to move the gray cursor to the corresponding screen. Press the knob to enter the screen of SpO₂, Trend, Recall, ARR, Setup, Color, and File. The following sections from chapter 4.7 will describe each one of the 8 screens. If you want to exit from this screen, press the Display Key.

4.5 SpO2 Data List Screen

Move the gray cursor to SpO₂ List in the mode selection screen, and press Navigation Knob to enter into SpO₂ data list screen, displays in the same position shown as Figure 4.13.

Time	HR	SYS	DIA	MAP	RR	TEMP	SpO ₂	Pulse
08:47	60	126	82	108	15	36.5	98	62
08:47	60	126	82	108	16	36.7	99	60
08:47	60	126	82	108	14	36.5	98	62
08:46	60	126	82	108	16	36.7	99	62
08:46	60	126	82	108	14	36.7	99	61
08:46	60	126	82	108	14	36.5	99	62

Figure 4.13 SpO₂ List

4.5.1 Screen Description

In the SpO₂ list title bar, the front color of SpO₂, Pulse is the same with SpO₂ parameters' and other front color is white.

The operation on the data listing is simple. Using the Navigation Knob allows the user to scroll the list up and down. When rotating the knob anti-clockwise, the list scrolls upward (i.e. use the ↑ arrow to scroll the data). When rotating knob clockwise, the list scrolls down (i.e. use the ↓ arrow to scroll the data).

All the parameters in the SpO₂ data list are corresponding to the time when the SpO₂ measurements were taken. There is only one record every 4 seconds.

4.6 Trend Screen

4.6.1 Screen Description

Move the gray cursor to the "Trend" button, press the knob, you will get the trend menu screen as shown in Figure 4.14.

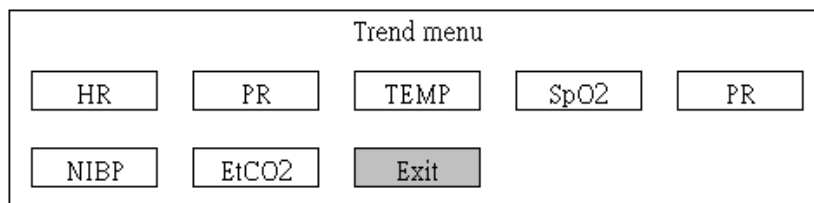

Figure 4.14 Trend Menu

If you want to enter one of the trend graphs, the procedures are: rotate the knob, move the cursor to one of the parameter. For example, from the left to right, we are entering "Heart Rate", "SpO₂" and "NIBP" trend graphs. These screens are described in the following Figures.

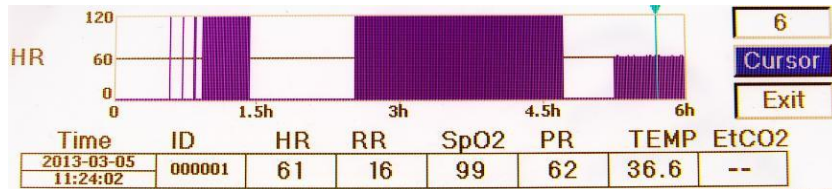

Figure 4.15 HR Trend Graph

Figure 4.15 is the ECG trend graph. There are 3 options on the right of the graph, as described below.

The “12” on the top shows the trend graph time. Move the cursor to the trend time, press the knob and rotate the knob. The trend graph time will change to 24 or 96, which changes the horizontal axis to be 24 hours or 96 hours. The corresponding trend graph also changes to 24-hour trend or 96-hour trend.

After choosing “Scan”, the trend graph display a triangle and a vertical line. This is a moving data marker. As shown in the picture, when you move the marker to a specific point, the data area below the graph will display the marker’s time, and its corresponding heart rate, SpO₂. When rotating the knob to move the marker, the moving interval is a changing value. The rule is as following: the initial step is 1. After you move towards the same direction 5 times, the interval becomes 5, after 5 more steps, the interval becomes 10, and therefore it can go to 20, 40.

No matter what your interval is, as soon as you move toward the other direction, the interval becomes 1 on the other direction. Therefore, it is very easy to find the time you are looking for.

The last button is “Exit”. Move the cursor to the Exit button, and press the knob to return to the previous level screen. The screen returned to is the Trend menu screen as shown in 4.14.

Please note that the max value on the vertical axis of the ECG is 120, not the max value of the ECG upper limit. The scaled down graph provide better waveforms. When the ECG value exceeds 120, the vertical axis max value will automatically change to 240. The three value to change to 0, 120, 240 from 0, 60, 120 for reference. When system gets reset or the patient ID has changed, the vertical axis will return to its original value of 0, 60, and 120. Other changes of vertical axis value in other trend graph are similar to that of ECG.

The Trend graph shows parameter value of the current time. For example, in the 12 hours trend graph, when the monitoring time exceeds 12 hours, the trend graph will move toward the right and the data 12 hours ago will be moved out of the graph. This ensures the screen always displays the current data for review. The data moved out of the graph is not deleted, they are just hidden temporarily. When the time frame changes from 12 hours to 24 hours (while the monitoring time is less than 24 hours), the complete set of data will display. Other trend graph follows the same rule.

The other trend graph are similar to that of ECG trend graph and we will not cover them in detail again. Please note that for those trend graphs, the horizontal axis unit is number of time the blood pressure is measured in stead of time.

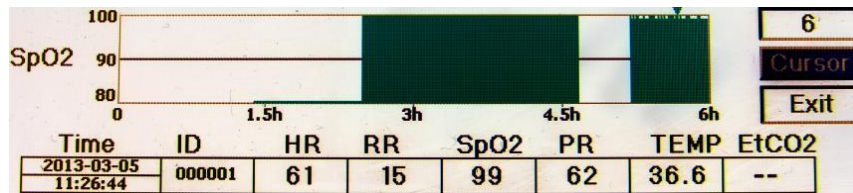

Figure 4.18 SpO2 Trend Graph

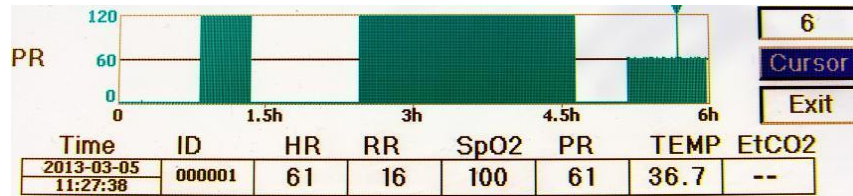

Figure 4.19 PR Trend Graph

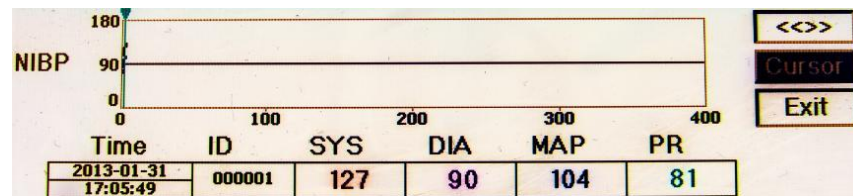

Figure 4.20 NIBP Trend Graph

4.6.2 Operating Instructions

Rotate the knob, choose the parameter and press the knob. Review the trend graph and move the cursor to the Exit button to exit the trend graph.

4.7 Recall Screen

Move the cursor to “RCALL” in the mode selection screen and press the navigation knob, the system enters in the waveform recall screen.

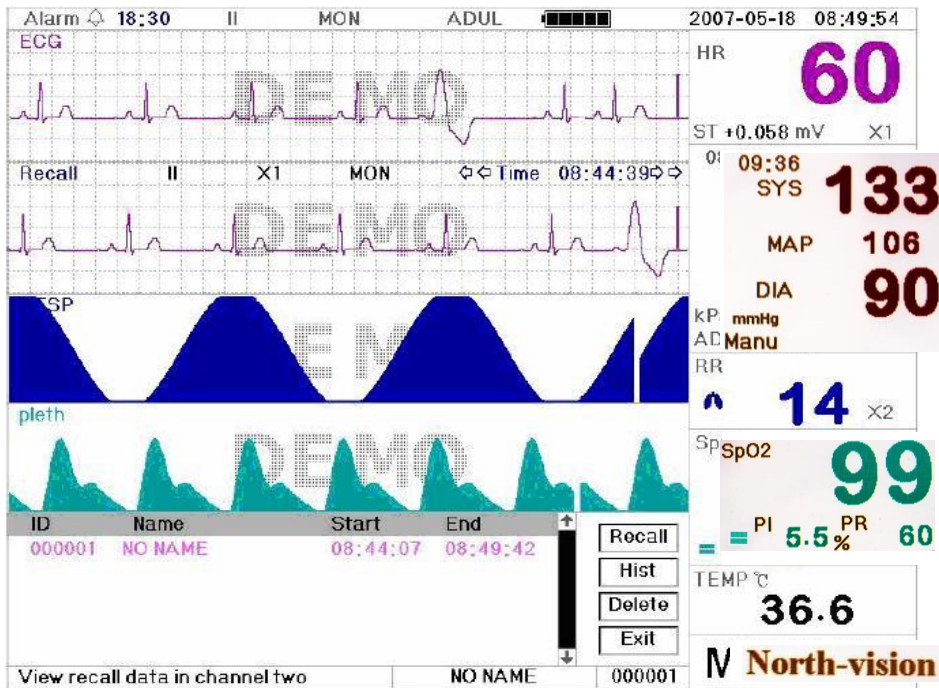

Figure 4.22 Waveform Recall Screen

The waveform recall screen is shown in Figure 4.22. It is different from the main screen in its 2nd waveform area and the operation area. We will cover them in detail below.



Figure 4.23 Recall List

Rotate the knob and choose “Recall”, “HIST”, “Delete” and “Exit” button. We explain each button’s function below.

Recall: press the Recall button; the first list on the recall listings becomes highlighted. Rotate the knob to choose the record. Press the knob to perform the recall. The recalled waveform displays on the 2nd channel of the waveform area, as shown in Figure 4.24.

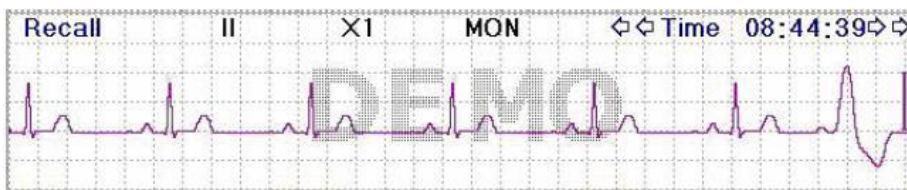

Figure 4.24 waveform Recall

Rotate the knob to move forward and backward of the recalled waveform. Press the knob to exit the waveform recall and return to the initial state of the waveform recall screen.

During waveform recall, the system not only displays the current recalled waveform, it also displays the lead status, gain and filter type for the waveform.

HIST: press this button to switch the button between the history button and current button. Press the History button the recall listing on the left side displays the history listing. Press the Current button, the recall list on the left side displays the current listings. When entering the recall screen, the system defaults to the current listing.

Delete: press this button, the record on the recall list become highlighted. Rotate the knob to choose the record being deleted. Press the knob and hold for 2 seconds and release the knob. The record will be deleted. The current record cannot be deleted.

Exit: press this key to return to the system setup menu.

In this screen, the system can print the recalled data or the recalled waveform.

4.8 The Menu Setup Screen of the System

4.8.1 Screen Description

During the Mode Selection screen, move the cursor to the “SETUP” and press the knob. The screen shows the system setting screen as shown in Figure 4.26.

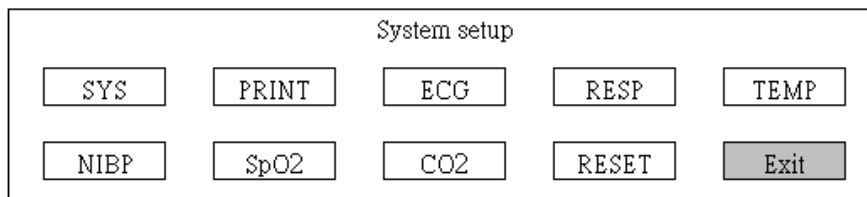

Figure 4.26 System Settings

To set up the system parameter, rotate the knob and move the cursor to the corresponding button, press the knob to perform the corresponding system settings.

Press the DEF button will make settings returned to the factory default and will not change the patient document and the recalled data. Our instructions will cover the functions of each button.

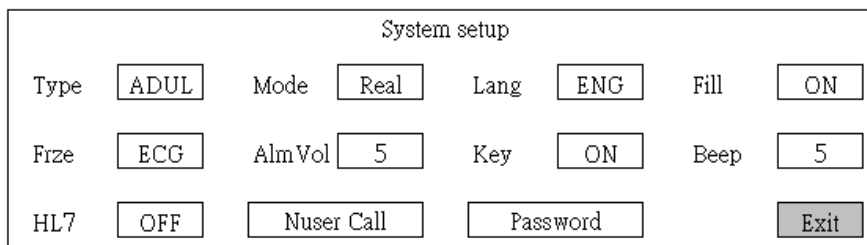

Figure 4.27 System Parameter Settings

- ✧ **Type:** The subject being monitored, this can be chosen among Adult and Pediatric patient. The factory default is “Adult”
When changing the patient type, the system will perform initiation of the alarm settings, NIBP settings. Please pay special attention to the patient type before starting the monitoring. It is strictly forbidden to use Adult type on the pediatric patient. Doing so can cause serious injury.
- ✧ **Mode:** Monitoring mode selection. The “Near real” shows the near real-time waveform, i.e. normal monitoring state. The DEMO shows the demo waveforms. During the demo state, all the signals and data are generated from the patient monitor for demo and testing purpose. The factory default is “Near Real-time”.
- ✧ **Lang:** Language is the setting for the display language. The factory default is English.
- ✧ **Fill:** When the fill setting is ON, the display fills the volume for the SpO2. When it is OFF, the system displays the line graph. The default is OFF.
- ✧ **Frze:** Freeze controls the waveforms being frozen when the Freeze button is pressed. The options are “All” and “ECG”. When ECG is selected, the system only freezes the ECG waveform. When “All” is selected, the system freezes all the waveforms including ECG, SpO2. The factory default is “ECG”
- ✧ **AlmVol:** The alarm sound volume. The max volume is 7 and min is 0, i.e. no sound. The factory default is 5.
- ✧ **Key:** keystroke sound. The factory default is ON.
- ✧ **Beep:** The Pulse rate sound volume. The max volume is 7 and min is 0, i.e. no sound. The factory

default is 5.

- ✧ **HL7:** Monitoring to hl7 format output measurement signal.
- ✧ **Nuser Call:** Nurse call signal output can be provided in the monitoring process.
- ✧ **Password:** The need for the administrator password for a specific project input.

4.8.2 Print Parameter Settings

Print setup			
Print	<input type="text" value="ON"/>	Timer	<input type="text" value="OFF"/>
Wave2	<input type="text" value="Pleth"/>	Wave3	<input type="text" value="RESP"/>
ARR	<input type="text" value="OFF"/>	<input type="button" value="Exit"/>	

Figure 4.28 Print Parameter Settings

- ✧ **Print:** Choose to open the printer function, The default is “ON”.
- ✧ **Timer:** Regular printing time, The options are “OFF · 1 · 2 · 3···240 Minute”, Chose a time “XX” minutes, when the exit the setting screen after the time the countdown to the end of the countdown is triggered to print the current screen, and will be printed once after every XX minutes, the factory default setting is “OFF”
- ✧ **wave2:** Select second Road waveform to print, choose “volume map” or “breathing”, factory set value of the “volume map”.
- ✧ **Wave3:** Select third Road waveform to print, choose “volume map” or “breathing”, factory set value of the “breathing”.

4.8.3 ECG Parameter Settings

ECG setup							
Lead	<input type="text" value="II"/>	Gain	<input type="text" value="X1"/>	Speed	<input type="text" value="25"/>	HR Hi	<input type="text" value="180"/>
Mode	<input type="text" value="MON"/>	Pace	<input type="text" value="OFF"/>	1mV	<input type="text" value="OFF"/>	Lo	<input type="text" value="40"/>
Notch	<input type="text" value="60Hz"/>	Grid	<input type="text" value="ON"/>	<input type="button" value="Exit"/>			

Figure 4.29 ECG Settings

- ✧ **Lead:** Can choose from I, II, III, AVR, AVL, AVF, V (V1-V6), and GND. The factory default is II.
- ✧ **Gain:** The ECG gain, 5 options $\times 1/2$, $\times 1$, $\times 2$, $\times 4$ and Auto. Auto is for automatic gain control. The factory default is $\times 1$.
- ✧ **Speed:** ECG display speed. 3 options: 12.5, 25, 50 mm/s. The factory default is 25 mm/s.
- ✧ **HR Hi:** Heart rate upper alarm setting
Lo: Heart rate lower alarm setting
- ✧ **Mode:** ECG filter mode. Three options: MON, DIA, and OPE, The factory default is MON.
MON: Monitoring mode, moderate filtering. It can filter out interference and present good ECG waves.
DIA : Diagnosis. No filtering. It represents the true ECG without filtering.
OPE: Operation. Deep filtering. It can filter out strong interference.
- ✧ **Pace:** Cardiac pacemaker detection. When Pace is “ON”, a mark will be displayed on the ECG waveform if the patient fitted with a cardiac pacemaker. The factory default is OFF.
- ✧ **1mV:** Generating the 1mv signal. This signal is used to test the function of the machine. It is not used

during normal operation. Factory default is “OFF”.

- ✧ **Notch:** ECG waveform filter, “50 Hz” To do 50hz filtering said ECG waveform, “60 Hz” To do 60hz filtering said ECG waveform, ”OFF” Do not do filtering, Factory default is “50Hz”.
- ✧ **Grid:** The grids will be displayed on the background if this setting is “ON”. The factory default is ON. Move the cursor to the upper or lower limits of the alarm settings, and press the Alarm key to turn ON and OFF the alarm for the setting. Yellow color shows ON status, and gray color show the OFF status.

4.8.4 NIBP Parameter Settings

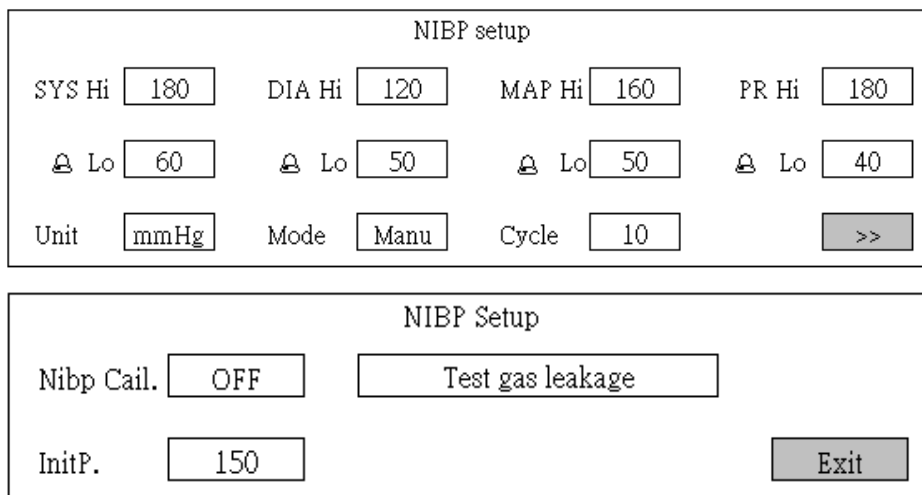
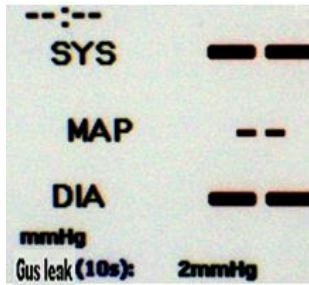

Figure 4.33 NIBP Settings

- ✧ **SYS Hi/Lo:** Systolic pressure upper and lower alarm limits.
- ✧ **DIA Hi/Lo:** Diastolic pressure upper and lower alarm limits.
- ✧ **MAP Hi/Lo:** Mean arterial pressure upper and lower alarm limits.
- ✧ **PR Hi/Lo:** Pulse rate upper and lower alarm limits.
- ✧ **Unit:** the pressure unit. mmHg or kPa. The factory default is mmHg.
- ✧ **Mode:** The cuff inflation mode, manual or automatic. The factory default is manual. The operator needs to press the NIBP button to perform NIBP measurement.
- ✧ **>>:** Next page.
- ✧ **Nibp Cail.:** This option is for the provision of factory calibration of the machine, "OFF", "Mode 1" and "Mode 2". The factory default value: "Off".
- ✧ **initP.:** initial pressure of nibp measurement.

- ✧ **Test gas leakage:** This option provides the cuff with test leak with turning the rotary knob will highlight the cursor position in the test leak position rotary knob will leak testing, test results and blood pressure zone.



WARNING: STAT can only be used for Adult. Using this mode to pediatric patient can cause serious injury.

4.8.5 SpO2 Parameter Settings

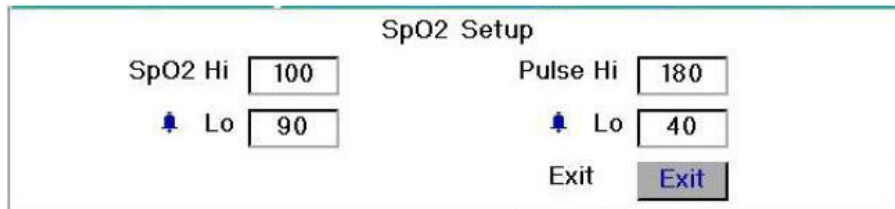

Figure 4.34 SpO2 settings

SpO₂ Hi/Lo: SpO₂ upper and lower alarm settings, adjustable 1-100/0-99.

Pulse Hi/Lo: Pulse rate upper and lower alarm settings, adjustable 21-250/20-249.

4.8.6 Reset

System parameters default key. Move the cursor to “RESET”, press the Navigation knob for 2seconds, all the value of parameters will resume default except the setting of language and printer type.

4.9 Color Settings Screen

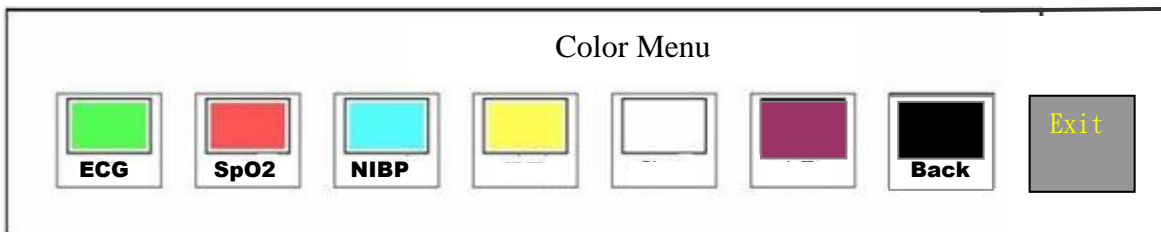

Figure 4.36 Color Setting Screen

In this screen, rotate the knob to choose the color, press the knob and rotate it to change the color. When the appropriate color is chosen press the knob again to save it.

Press the Exit to exit this color settings screen.

Only the background color (BACK) can use the color black. The background color can not be the same as other color.

4.10 File/Patient Management Screen

File Manager						
ID	000001	Name	NO NAME	Save	OFF	Disk
Bed		Sex	M	Age	30	Exit
-----			0 1 2 3 4 5 6 7 8 9 A B C D E F G H I J K L M N O P Q R S T U V W X Y Z -			Exit

Figure 4.37 File Management settings

The document/patient management screen can be used to manage information about the patient. In the screen, the operator can enter the patient ID, name, bed number, sex, and age. The operator can also choose to save the patient data in the permanent storage. The screen is shown in Figure 4.32.

ID, or Patient ID. To enter patient ID, choose the patient ID field using the rotate knob. Press the rotate knob to enter the text entry box. Rotate the knob to choose the letter and press the knob to enter the letter. To delete the letter, move the cursor to the letter to be deleted and rotate the knob to enter spaces (after the Z). Use the spaces to replace the letters. After finishing entering the patient ID, choose Exit button and press the knob to exit the text entry. The patient ID is the unique identifier for the patient. When the patient ID changes, the system considers the patient has changed.

Name: Enter the patient name.

Bed: Enter the bed number.

Sex: Choose between M or F for male and female.

Age: Choose the age field and use the rotate knob to select an age.

Save: The operator can choose how much of the data that needs to be saved. The unit is hour. Once the time is chosen, the system starts to save data from the current time. The factory default is OFF.

Time: Use the Navigation Knob to set the time of data saved. Save is not available if the Time is 0.

Disk: Move the cursor on "Disk", press the Navigation Knob to read the information of Disk.

Chapter 5 Technical Specifications

5.1 ECG Monitoring

1. Input signals range in amplitude: $\pm 0.5 \text{ mV} \sim \pm 3 \text{ mV}$
2. Heart rate display range: 15bpm ~ 300 bpm
3. Heart rate display accuracy: $\pm 1\%$ or $\pm 2 \text{ bpm}$, whichever is greater.
4. Heart rate alarm delay time: $\leq 10 \text{ s}$
5. Sensitivity selection: $\times 1/2$, $\times 1$, $\times 2$, $\times 4$, Auto, tolerance: $\leq \pm 5\%$
6. Sweeping speed: 12.5mm/s, 25mm/s, 50mm/s tolerance: $\leq \pm 10\%$
7. ECG noise level: $\leq 30 \mu\text{V}_{\text{p-p}}$.
8. ECG input loop current: $\leq 0.1 \mu\text{A}$
9. Differential input impedance: $\geq 5 \text{ M}\Omega$
10. Common-mode rejection ratio (CMRR): $\geq 80 \text{ dB}$
11. Time constant:
 - Monitoring Mode: $\geq 0.3 \text{ s}$
 - Diagnosis Mode: $\geq 3.2 \text{ s}$
12. Frequency response:
 - Monitoring Mode: 1Hz~25 Hz (+ 0 . 4 d B
- 3 . 0 d B)
 - Diagnosis Mode: 1 Hz~75 Hz (+ 0 . 4 d B
- 3 . 0 d B)
13. The recovery time after defibrillator charge: $< 10 \text{ sec}$

5.2 NIBP Monitoring

Measuring method: Intelligent Oscillometric method

Cuff inflation time: ≤ 10 seconds (typical adult cuff)

Air release time while the measurement is canceled: ≤ 2 seconds (typical adult cuff)

Initial cuff inflation pressure

Adult: $< 180 \text{ mmHg}$ pediatric: $< 120 \text{ mmHg}$

Overpressure protection limit

Adult: 300 mmHg pediatric: 300mmHg

NIBP measurement range:

Systolic : 20 mmHg~290 mmHg

Diastolic : 10 mmHg~260 mmHg

MAP : 15 mmHg~275 mmHg

NIBP accuracy:

Systolic : $\pm 5 \text{ mmHg}$

Diastolic : $\pm 5 \text{ mmHg}$

MAP : ± 5 mmHg

Measurement mode: Manual, Auto

Measurement Method: Adult, Pediatric

5.3 SpO₂ Monitoring

Transducer: Dual-wavelength LED

SpO₂ measuring range: 0%~100%

SpO₂ measuring accuracy: Arms is not greater than 2% for SpO₂ range from 70% to 100%

SpO₂ measurement accuracy :

(1) 70%~100% $\pm 2\%$

(2) Below 70%, the value is only for reference without exact definition, the symbol for % means the "SpO₂ Percentage".

PI range: 0.4% ~ 20%

5.4 Pulse Rate monitoring

Pulse rate measuring range: 15bpm~300bpm

Pulse rate measuring accuracy: ± 2 bpm or $\pm 2\%$, whichever is greater.

5.5 Data Recording

Sensitivity selection tolerance: $\leq 5\%$

Recording speed: 25mm/s

Recording speed accuracy: $\leq 5\%$

5.6 Other Technical Specifications

Power supply: 100~240VAC, 50/60Hz

Power consumption: <100VA

Display mode: 10.4 inches TFT color LCD

Alarming mode: Audible & visible alarm

Communication: NET(RJ45)

5.7 Classification

Safety standard	IEC 60601-1
The type of protection against electric shock	Class I equipment.
The degree of protection against electric shock	Type BF, CF applied parts
Electro-Magnetic Compatibility	Group I, Class A
Protection against ingress of water	IPX1

5.8 Default Alarming Values of All Parameters

Parameter	Mode	Adult	Pediatric
	Heart Rate	High	180bpm
Low		40bpm	50bpm
Systolic	High	180mmHg	130mmHg
	Low	60mmHg	50mmHg
Diastolic	High	120mmHg	90mmHg
	Low	50mmHg	40mmHg
MAP	High	160mmHg	110mmHg
	Low	50mmHg	40mmHg
SpO2	High	100%	100%
	Low	90%	85%
Pulse Rate	High	180bpm	200bpm
	Low	40bpm	50bpm

Alarm high and low limits: when the parameter value is higher than the high limit or lower than the low limit, the system will alarm.

In the monitoring screen, press the Alarm key to activate the alarm timer. The time shows up on the high limit left corner of the screen. When the alarm timer is activated, the system will activate the alarm function when the specified time has passed.

Alarm timer has 4 options: 2 min, 5 min, 10 min, 20 min, or during alarm.

Chapter 6 Packaging and Accessories

6.1 Packaging

The product is packed in high quality corrugated cartons with foam inside to protect the equipment against damage in the shipping and handling process.

Gross Weight: see the packaging

Dimensions: 500mm x 320mm x 460mm

6.2 Accessories

- (1) ECG lead cable One set
- (2) NIBP cuff One set
- (3) SpO₂ probe One piece
- (4) Power cable One piece
- (5) Grounding wire One piece
- (6) Disposable electrode Ten pieces
- (7) User Manual One copy
- (8) Warranty One copy
- (9) Printing paper (optional) Five rolls
- (10) Dust cover One set
- (11) Assembly report One set
- (12) Packing list One piece

Note: The accessories are subject to change. Detailed items and quantity see the Packing List.

Chapter 7 Monitoring Parameters

7.1 Measuring ECG

The electrocardiogram (ECG or EKG) is primarily a tool for evaluating the electrical events within the heart. The action potentials of cardiac-muscle cells can be viewed as batteries that cause charge to move throughout the body fluids. These currents represent the sum of the action potentials occurring simultaneously in many individual cells and can be detected by recording electrodes at the surface of the skin. Figure below shows the system of the heart.

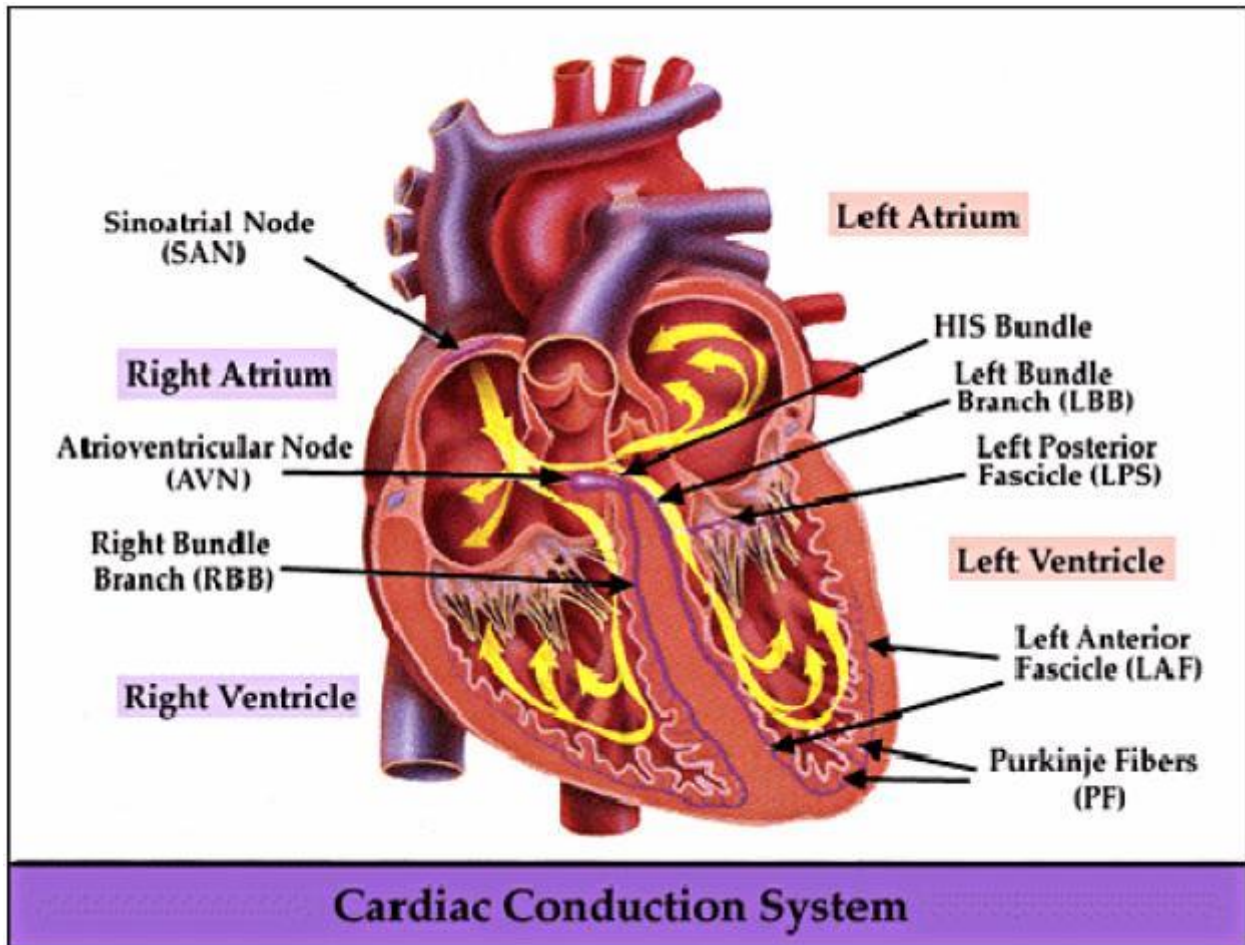

To obtain the high quality ECG signal, the hospital or the clinic should get ready the three-phase power supply system with standard ground wire. If excessive interference exists, connect one end of the ground wire provided with this equipment to the grounding pole on the back panel of this monitor, and the other end to the special ground wire, water pipe or radiator.

A common ECG plate electrode used together with this monitor has a short shelf life. Generally, the shelf life is only one month after the package is opened. When outdated plate electrode is used, due to skin's contact impedance and large electrode potential, the chance of interference will be increased, and the ECG baseline will become unstable. Therefore, always use valid plate electrodes.

7.2 The Principle for Measurement of the Blood Pressure

Blood pressure may be measured in an invasive manner (whereby the sensor will be inserted into blood vessel directly) or a non-invasive manner. The non-invasive methods include several methodologies, the Korotkoff-souna method and oscillating method. The Korotkoff-souna method is used as a conventional way, whereby stethoscope is used to measure the blood pressure. By the oscillating method, an inflation pump will fill the cuff, and release the air slowly. A computer will record change of the cuff pressure when the air is released. With this record, the blood pressure valve will be determined. First of all, make sure the signal quality obtained by computer meets the requirements of accurate calculation (sudden limb movement or cuff being hit during the measurement may invalidate the data). If the answer is negative, give up the calculation. If the answer is positive, carry on the calculation of the blood pressure value.

As change of the blood pressure is recorded by electric sensor, which sensitivity is much higher than that of human ears, the oscillating method uses different definitions for measurement of diastolic pressure, mean arterial pressure and systolic pressure from the Korotkoff-souna method. When the oscillating method is used, the circuit in the measuring equipment will separate the amplitude of the cuff pressure from its change with pulsation. With the oscillating method, the blood pressure at the maximum amplitude of cuff pressure is defined as the mean arterial pressure. The blood pressure at amplitude of cuff pressure forward reduced by 50% is defined as systolic pressure, while the blood pressure at amplitude of cuff pressure backward reduced by 80% is defined as diastolic pressure. The maximum change of pulse pressure occurs at these two points. They are equivalent to the point with pulse sound and the point without pulse sound respectively in the Korotkoff-souna method.

When the risk of invasive monitoring method outweighs its advantage of accuracy, non-invasive monitoring method shall be used.

7.2.1 Comparison between Blood Pressure Measuring Methods

To overcome the effect of human hearing variation and air release speed on measurement accuracy when the conventional Korotkoff-souna method is used to take measure of blood pressure, people have been dedicated to study of automatic measurement of blood pressure. By now, automatic blood pressure measuring system based on the principle of oscillating method is mature. In practice, however, various problems are encountered, why the measures taken by the oscillating method is lower or higher than those taken by Korotkoff-souna method? Why the measures are inclined to decline? Why, in some cases, no result is obtained in spite of the inflation actions? Why the measure values have big discreteness, and even abnormal data in some cases? Why the pulse oxygen waves may disappear suddenly? The following explanations are devised to give the answers.

The oscillating method vs. the Korotkoff-souna method

Blood pressure measurement by the oscillating method and Korotkoff-souna method has good correlation with the invasive measurement. Notwithstanding, any of the non-invasive blood pressure measurements has its weakness when it is compared to the invasive measurement. The oscillating method has its advantages over the Korotkoff-souna method for its less error, higher reliability and stability. Their differences may be reflected in the following aspects.

1. The measures by the Korotkoff-souna method are liable to effect of human factors. For example, different people may have different sound judging ability, or different reactivity when listening to heart sound and reading mercury meter. The air release speed and subjectivity may also affect the judgment. By the oscillating method, the computation is accomplished by the computer, thus relieving the possibility of effect due to human factor.
2. With the Korotkoff-souna method, the measure is taken on the basis of appearance and disappearance of heart sound. The air release speed and heart rate may have direct effect on the measurement accuracy. It also has the disadvantages of rapid air release and poor accuracy. In the contrast, with the oscillating method, the determination is calculated on the basis of cuff pressure oscillatory wave envelope, and the air release speed and heart rate has little effect on the measurement accuracy.
3. Statistics show that, when measuring the hypertension, the measure taken by the oscillating method is likely to be lower than that taken by the Korotkoff-souna method. When measuring the hypotension, the measure taken by the oscillating method is likely to be higher than that by the Korotkoff-souna method. However, it doesn't mean the advantages or disadvantages between the oscillating method and the Korotkoff-souna method. Comparison with the results taken by more accurate method, for example, comparison of the invasive pressure result with the output value by the blood pressure measuring simulator, will show which method has more accurate results. In addition, higher or lower value should be a statistical concept. It is recommended those used to adopt the Korotkoff-souna method use different physiological calibration for values determined by the oscillating method.
4. The studies have shown that the Korotkoff-souna method has the worst accuracy when it comes to measurement of hypotension, while the oscillating method has worse accuracy when it comes to measurement of controlled hypertension relief.

7.3 Measuring the Blood Pressures

7.3.1 Operational Tips

Like common non-invasive blood pressure measurement, improper operation may cause inaccurate or no result, or misunderstanding of the measuring information when the oscillating method is used to take the measure of blood pressure.

1. Requirements of the cuff:
 - 1) Appropriate cuff should be selected according to the age of the subject.
 - 2) Remember to empty the residual air in the cuff before the measurement is commenced.
 - 3) Locate the cuff in such a way that the “φ” mark is at a location where the clearest pulsation of brachial artery is observed.
 - 4) The cuff should be tightened to a degree where insertion of one finger is allowed.
 - 5) The lower end of the cuff should be 2cm above the elbow joint.
2. The subject should lie on the back so that the cuff and the heart are in a horizontal position and the most accurate measure can be taken. Other postures may lead to inaccurate measurement.
3. Do not speak or move before or during the measurement. Care should be taken so that the cuff will not be hit or touched by other objects.
4. The measures should be taken at appropriate intervals. Continuous measurement at too short intervals may lead to pressed arm, reduced blood flow and lower blood pressure, and resulting in inaccurate measure of blood pressure. It is recommended the measure be taken at intervals of more than two minutes.
5. With the oscillating method, when blood pressure is measured, the inflation pressure of the cuff will be automatically adjusted according to the previous measurement. Generally, the initial inflation pressure is 180mmHg (for the adult mode) or 100mmHg (for the pediatric mode) or 80 mmHg (for the newborn mode) when it is powered on. Following that, 50mmHg (for the adult mode) or 30mmHg (for pediatric mode) or 10mmHg (for the newborn mode) will be added on the basis of the last measurement of systolic pressure. In this way, when the blood pressure rises or the subject is changed, the blood pressure meter may not give the result after the first-time inflation. This monitor will automatically adjust the inflation pressure up to 4 times until the accurate measurement is taken.
6. When an adult subject is monitored, the machine may fail to give the blood pressure measurement result if the pediatric or newborn mode is selected.

7.3.2 Clinical Limitations (Contraindications)

Please do not perform the monitoring for the patient with the following conditions.

1. Serious angiospasm, vasoconstriction, or too weak pulse.
3. Do not perform the measurement when the subject is connected with an artificial heart-lung machine.
4. Do not perform the measurement when the subject uses diuresis or vasodilator.
5. When the subject is suffering from major hemorrhage, hypovolemic shock and other conditions with rapid blood pressure change, the reading will not be reliable, for reduced peripheral blood flow will lead to reduced arterial pulsation.

6. Subject with hyperadiposis.

In addition, statistics show that 37% people report blood pressure difference of no less than 0.80kPa (6mmHg) between the left and right arms, and 13% people report difference of no less than 1.47kPa (11mmHg).

Note: Some practitioners may report big discreteness or abnormal value of the blood pressure measures when the oscillating method is used. As a matter of fact, the so-called “big discreteness” must be a term in the sense of statistical significance of mass data. Abnormal data may be observed in some individual cases. It is normal in the scientific experiments. It may be caused by an apparent reason, or by an unknown factor in some cases. Such individual doubtful experimental data may be identified and eliminated using the special statistical technique. It is not a part of this manual. The practitioner may eliminate the apparently unreasonable data according to the experience.

Operation Introduction:

1. Take a measurement in manual mode:

- ◆ Enter into the screen of NIBP setting, select “Mode” option and set it as “MANU”, and then press the NIBP key on the front panel to start measure. If press the NIBP key again, the measurement will be stopped.

7.4 Measuring the Pulse Oxygen Saturation and Pulse Rate

This monitor measures the pulse oxygen saturation and the pulse by means of the radiograph of infrared light and the red light emitted by LED through body's peripheral areas (fingers), whereby the photoelectric detecting circuits will analyze the absorption of the oxy-hemoglobin and reduced hemoglobin respectively, and give the photo-absorption rates before and after pulsation. By measuring photo-absorption change due to pulse arterial blood flow caused by PLETH wave, the pulse oxygen saturation can be obtained.

7.4.1 Operational Tips

1. The fingers should be properly placed (see the attached illustration of this instruction manual), or else it may cause inaccurate measurement result.
2. The pulse oxygen saturation sensor and photoelectric receiving tube should be arranged in a way with the subject's arteriole in a position there between.
3. The pulse oxygen sensor should not be used at a location or limb tied with arterial or blood pressure cuff or receiving intravenous injection.
4. Do not fix the pulse oxygen sensor with adhesive tape, or else it may result in venous pulsation and consequential inaccurate measure of SpO₂.
5. Make sure the optical path is free from any optical obstacles like adhesive tape.
6. Excessive ambient light may affect the measuring result. This includes fluorescent lamp, dual ruby light, infrared heater, direct sunlight and etc.
7. Sudden and excessive movement of the subject or extreme electrosurgical interference may also affect the accuracy.

7.4.2 Clinical Limitations (Contraindications)

1. As the measurement is taken on the basis of arteriole pulse, substantial pulsating blood flow of subject is required. For a subject with weak pulse due to shock, low ambient, major bleeding, or use of vascular contracting drug, the pulse oxygen wave (PLETH) will decrease. In this case, the measurement is more sensitive to interference.
2. For those with a substantial amount of staining dilution drug (methylene blue, indigo green and acid indigo blue), or carbon monoxide hemoglobin (COHb), or methionine (Me+Hb) or thiosalicylic hemoglobin, and some with icterus problem, the pulse oxygen determination by this monitor may be inaccurate.
3. The drugs dopamine, procaine, prilocaine, lidocaine and butacaine may also be a major factor for serious error of pulse oxygen measures.
4. The pulse oxygen value serves only as a reference value for diagnosis of anemic anoxia and toxic anoxia because some patients with serious anemia may also report good pulse oxygen measure.





Chapter 8 Maintenance

The multi-parameter patient monitor should be properly maintained to ensure its maximum performance and long service life. In addition to the warranty period of one year, the company also offers long-term service for each customer.

It is important that the users read and follow the operating instructions, important information and maintenance measures.





8.1 Protective Maintenances

Before using the monitor, the checks below should be carried out:





-  Check the monitor for any mechanical damage;
-  Inspect the exposed parts and the inserted parts of all the leads, and the accessories;
-  Examine all the functions of the monitor that are likely to be used for patient monitoring, and ensure that it is in good working condition;
-  Make sure that the monitor is grounded properly.
-  Pay close attention to the fluctuation of the local power supply voltage. A manostat is recommended when necessary.

In case any indication of damage about the function of the monitor is detected and proven, it is not allowed to apply it to the patient for any monitoring. Please contact the local dealer or our company, and we are to offer the best solution as soon as possible for your satisfaction.





After each maintenance or the yearly maintenance, the monitor must be thoroughly inspected by qualified professional, including function and safety examinations.

-  **If the hospital fails to carry out a satisfactory maintenance program about the monitor, it may get disabled and harm the patient's safety and health.**
-  **In case of ECG leads damage or aging, please replace the lead.**
-  **If there is any indication of cable and transducer damage or they deteriorate, they are prohibited from any further use.**
-  **The adjustable units in the monitor potentiometer are not allowed to adjust without permission to avoid unnecessary failures that affect normal application.**
-  **It is recommended to use the battery once a month to ensure its strong power supply capacity and long service life, and recharge it after run out of the power volume.**















8.2 Battery Maintenance

-  **Please pay attention to the polarity of battery, do NOT insert it into battery compartment with reversed polarities;**
-  **Do NOT use the batteries manufactured by other companies, if being inserted, the device will may be damaged;**
-  **In order to avoid damaging the battery, do NOT use other power supply device to charge the battery;**
-  **After battery ageing phenomenon occurring, do NOT throw the battery into fire to avoid**

explosion risk.

-  **Do not hit or strike it with force;**
-  **Do not use this battery on other devices;**
-  **Do not use this battery below -10°C or above 40°C;**
-  **In order to maintain battery supply time and prolong battery lifetime, please use the battery once a month and do not charge it until it is used up each time.**



8.3 Cleaning, Sterilization and Disinfection of the Monitor

-  **Switch off the monitor and disconnect the power cable before cleansing.**
-  Kept the monitor from dust.
-  It is recommended to clean the outer shell and screen of the monitor to keep it clean. Only non-corrosive cleanser clear water is permitted.
-  Wipe the surface of the monitor and transducers with an alcohol impregnated wipe, and dry it with dry and clean wipe or simply air-dry.
-  It is advisable to disinfect and sterilize the apparatus when necessary in the hospital maintenance program to avoid causing long term damage to the monitor, and to clear the sterilizing and disinfecting tools in advance.
-  **Do not let the liquid cleanser flow into the connector jack of the monitor to avoid damage.**
-  **Clean the exterior of the connector only.**
-  **Dilute the cleanser.**
-  **Do not use scrub materials.**
-  **Do not let any liquid flow into the shell or any parts of the monitor.**
-  **Do not let the cleanser and disinfectant stay on its surface.**
-  **Do not perform high pressure sterilization to the monitor.**
-  **Do not put any parts of the monitor in the liquid.**
-  **Do not pour the disinfectant on its surface while sterilization.**

1. Never use this machine in an environment with inflammable gas.
2. Avoid being hit by lightning. The power cable should be plugged into a outlet with grounding wire. Do not use an outlet with poor condition. If possible, use power supply system with manostat.
3. It must be used in a clean environment protected against shock. Keep it away from corrosive substances, explosive substances, high temperature and dampness.
4. If it is installed in a cabinet, make sure the installation allows for good ventilation, and easy to maintain, observe and operate.

8.4 Cleaning, Sterilization and Disinfection of Accessories

It is recommended to clean the accessories (including sensor, leads and plugs) with a piece of gauze which has been soaked in 75% Alcohol or 70% Isopropanol.

-  **Do not use damaged accessories.**
-  **Accessories can not be entirely immersed into water, liquor or cleanser.**
-  **Do not use radial, steam or epoxyethane to disinfect accessories.**

8.5 Storage

If the apparatus will not be used for long period of time, wipe it clean and keep it in the package, which shall be kept in a dry place free from dust.

Storage environment: ambient temperature: $-20^{\circ}\text{C}\sim 55^{\circ}\text{C}$

relative humidity: 10%~95%

atmospheric pressure: 50kPa~106kPa

8.6 Transportation

This monitor should be transported by land (vehicle or railway) or air in accordance with the contractual terms. Do not hit or drop it with force.

Chapter 9 Troubleshooting

Note: To troubleshoot this machine in the service, follow the instructions below to eliminate the problem first. If the attempt fails, refer to the dealer in your local area or the manufacturer. The service should be performed by a professional electrician. Do not open the machine by yourself.

9.1 No Display on the Screen

1. Shut down the machine and unplug the power. Use a universal multi-meter to check if the outlet has proper voltage, if the power cable is in good condition, and if the power cable is properly connected with this apparatus or the outlet? Remove the fuse from the back cover of this machine, and make sure it is in good condition.
2. If the trouble still exists, loosen the screws fastening the top cover of the machine and open the top cover. Check if the signal plug of the monitor is properly connected with the Type D jack on the right side of the display card

9.2 Excessive ECG Signal Interference or Thick Baseline

1. Check if the plate electrodes are properly located, and if valid plate electrodes are used.
2. Are the lead wires properly inserted? If no ECG curve is displayed, check if the ECG lead wires are broken.
3. Does the mains outlet have standard grounding wire?
4. Is the exclusive grounding wire of the apparatus properly grounded?

9.3 No Blood Pressure and Pulse Oxygen Measurements

1. Check if the blood pressure cuff is properly wrapped around the arm according to the operating instructions, if the cuff leaks, and if the inlet is closely connected with the NIBP jack on the front panel? Check if the indicator of the pulse oxygen probe flashes and if the pulse oxygen probe is properly connected to the SpO2 jack on the front panel.
2. Loosen the four screws fastening the top cover of this apparatus and check if the multifunctional board (MID) and electronic disc card (SCPU) nearest to the rear end of the LCD display are properly inserted in the slots on the main board.

9.4 System Alarm

1. When the parameter value is higher or lower than the alarm limits, the alarm will ring. Please check whether the alarm limit value is proper or the condition of the patient.
2. Leads off. Please check the connection of the leads.
3. Probe off. Please check the connection of the probes.

10.1 Other Terms and Messages

- “Cuff error” — cuff is not wrapped correctly, or is not connected
- “Air leak” — Pneumatic component, tubing or cuff leaks
- “Pressure error” — Unstable cuff pressure or tangled cuff tubing
- “Signal weak” — Very weak signal because of the cuff, or the patient has very weak pulse
- “Over extent” — The measurement range exceeds 255 mmHg (Pediatric 135 mmHg)
- “Over motion” — The repeated measurement due to moving, excessive noise during the stepping inflation and measuring pressure and pulse, e.g. during patient shaking motion
- “Signal overflow” — Blood pressure amplifier overflow due to excessive movement
- “Leak in gas run” — Leaking during the pneumatic device testing
- “System error” — Abnormal condition of CPU, register overflow, divided by zero
- “Adult” — The blood pressure measuring now is in adult mode. In this case, it is not allowed to monitoring Pediatric patient. Otherwise, there may be serious danger to the patient monitored.
- “Pediatric” — The blood pressure module is now worked in pediatric measuring mode.
- “LEADS OFF” — SpO₂ probe fell off
- “PROBE OFF” — The ECG electrodes or cable fell off
- “DEMO” — The instrument is working at demonstration mode, all signals are produced inside the instrument.

Manufacturer

North-vision Tech. Inc.

Address: 1st Fl., No.15, Gongye E. 2nd Rd., East Dist., HsinChu City 30075, Taiwan R.O.C.

International Sales

North-vision Tech. Inc.

Address: 1st Fl., No.15, Gongye E. 2nd Rd., East Dist., HsinChu City 30075, Taiwan R.O.C.

Tel +886 3-5771038

Fax +886 3-5771039

E-mail ahuang@north-vision.com

Website <http://www.north-vision.com>

Version 3.0

Issued date July 20, 2020

Information is subject to change and/or updating without notice.

Copyright © 2020 North-vision All rights reserved.

European Representative:

CMC Medical Devices & Drugs S.L.

C/Horacio Lengo N 18, CP 29006

Malaga, Spain

TEL: +34951214054 FAX:+ 34952330100